

LINK+

Rimadesio



THE LINK+ DESIGN EXPLORES ALL THE POSSIBILITIES OF LACQUERED GLASS DOORS, DISTINGUISHED BY THE EXCLUSIVE COLOURS OF THE RIMADESIO COLLECTION. ITS WIDE RANGE OF MATERIALS ALLOWS THIS DOOR TO BE USED NOT ONLY IN THE HOME, BUT ALSO IN RETAIL AND PUBLIC SPACES: GLASS, LITECH, SYNTHETIC LEATHER AND VARIOUS TYPES OF WOOD.

IT Link+ è un progetto che esplora tutte le possibilità della porta in vetro laccato, caratterizzata dalle tinte esclusive della collezione Rimadesio. L'ampia gamma di materiali in cui è realizzabile permette l'utilizzo all'interno di ambienti residenziali ma anche retail e pubblici: vetro, Litech, similpelle, essenze.

DE Link+ ist ein Projekt, das alle Möglichkeiten der lackierten Glastür erkundet und die exklusiven Farben der Rimadesio-Kollektion verwendet. Die große Auswahl an Materialien, aus denen diese Tür hergestellt werden kann, ermöglicht den Einsatz in Wohnräumen, aber auch im Einzelhandel sowie in öffentlichen Einrichtungen: Glas, Litech, Kunstleder, Holz.

FR Link+ est un modèle qui explore toutes les possibilités de la porte en verre laqué, caractérisée par les couleurs exclusives de la collection Rimadesio. La vaste gamme de matériaux avec lesquels cette porte peut être réalisée permet de s'intégrer dans des environnements résidentiels mais aussi commerciaux et publics: verre, Litech, similicuir, bois.

ES Link+ es un proyecto que explora todas las posibilidades de la puerta de cristal lacado, caracterizada por los colores exclusivos de la colección Rimadesio. La amplia gama de materiales en los que se puede realizar permite su uso en ambientes residenciales, comerciales y públicos: cristal, Litech, simil cuero, madera.

RU Link+ - это проект по исследованию всех возможностей двери из лакированного стекла, окрашенного в эксклюзивные цвета коллекции Rimadesio. Широкий ассортимент материалов, из которых он может быть выполнен, позволяет использовать его не только в жилых, но и в торговых и общественных помещениях: стекло, материал Litech, искусственная кожа, дерево.

汉语 Link+ 漆面玻璃门探索着所有设计的可能性，其特点为采用 Rimadesio 独有的系列色彩。不仅适用于居家空间，它亦能融入零售和公共环境；有种类繁多的材质可供选择，如：玻璃、Litech岩板、仿真皮革、木材。

EN A thin aluminium profile defines the perimeter of a pure surface that lives on reflections and the power of colours. Link+ is equipped with the lock system with magnetic latch, an innovative system patented by Rimadesio, allowing silence and reliability. Handles are available both in the swing and pocket version: a main aesthetical characteristic is the total integration between the handle block and the glass panel that create a unique and continuous surface.

IT Un sottile profilo in alluminio disegna il contorno di una pura superficie che vive di riflessi e della forza dei colori. Link+ è dotata della serratura con sistema di chiusura magnetico, un innovativo brevetto Rimadesio che assicura silenziosità e affidabilità nel tempo. Le maniglie sono previste sia per la versione battente che per quella scorrevole: caratteristica estetica principale è la totale integrazione fra blocco maniglia e pannello in vetro, che formano un'unica superficie ininterrotta.

DE Das hauchdünne Aluminiumprofil zeichnet den Umriss einer reinen Oberfläche, die von Reflexionen und der Kraft der Farben lebt. Link+ ist mit einem Magnetverschluss ausgestattet, einem innovativen Rimadesio-Patent, das im Laufe der Zeit für Ruhe und Zuverlässigkeit sorgt. Die Griffe sind sowohl für die Dreh- als auch für die Schiebeversion erhältlich: Das ästhetische Hauptmerkmal ist die vollständige Integration zwischen dem Griffblock und der Glasplatte, die eine einzige ununterbrochene Oberfläche bilden.

FR Un mince profil en aluminium dessine le contour d'une surface pure qui vit sur les reflets et la puissance des couleurs. Link+ est équipé d'une serrure avec système de verrouillage magnétique, un brevet innovant Rimadesio, qui garantit silence et fiabilité dans le temps. Les poignées sont fournies pour la version battante et glissante: la principale caractéristique esthétique est l'intégration totale entre le bloc de la poignée et le panneau de verre, qui forment une seule surface ininterrompue.

ES Un perfil fino de aluminio dibuja el contorno de una superficie pura que vive de los reflejos y el poder de los colores. Link+ está dotada de un sistema de cierre magnético, una patente innovadora Rimadesio que garantiza silencio y fiabilidad a lo largo del tiempo. Las manillas están disponibles tanto para la versión con batiente como la corredera: la característica estética principal es la integración total entre la cerradura y el panel de vidrio, que forman una única superficie ininterrumpida.

RU Тонкий алюминиевый профиль очерчивает контур чистой поверхности, которая живет отражениями и силой цвета. Дверь Link+ оснащена замком с магнитной системой запираения, инновационным патентом Rimadesio, который обеспечивает бесшумность и надежность на протяжении долгого времени. Ручки предусмотрены как для распашного, так и для раздвижного исполнения двери: главная эстетическая особенность — полная интеграция блока ручек и стеклянной панели, образующих единую, непрерывную поверхность.

汉语 纤薄的铝质型材勾勒出纯净的表面轮廓，映影和色彩交错，流露出灵动气息。Link+ 配备 Rimadesio 创新专利型磁吸关闭锁具，确保长时间使用依然柔静和值得信赖的开关体验。平开门和口袋门两种版本均带有把手：把手与玻璃门板相融为一体，形成一道延续不断的表面，是为这项设计主要的美学特征。





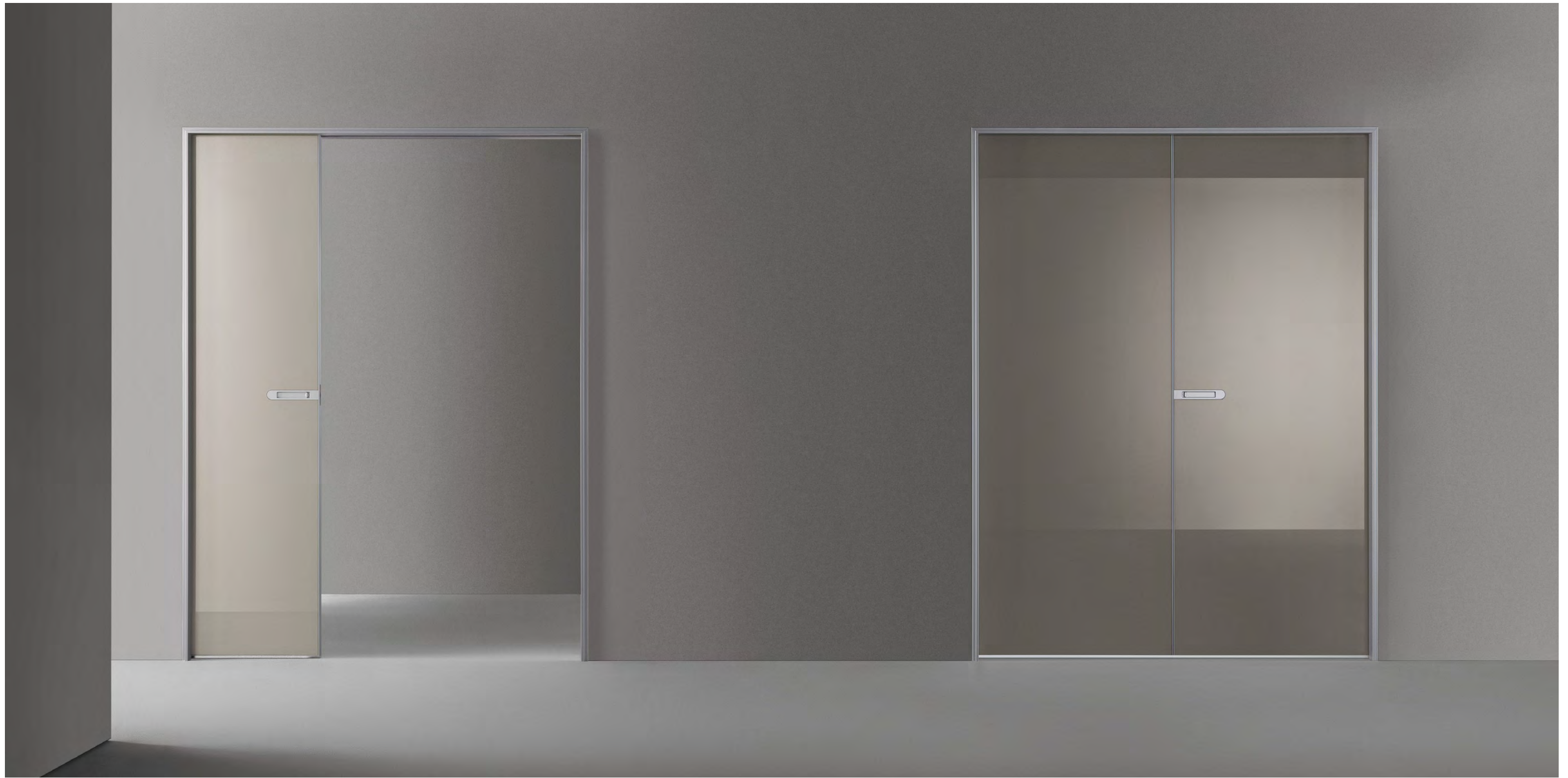



Structure and handle: 30 alluminio  
Glass: 56 lino lucido  
Handle with lever tumbler and door pull

SWING DOOR



SLIM SWING DOOR

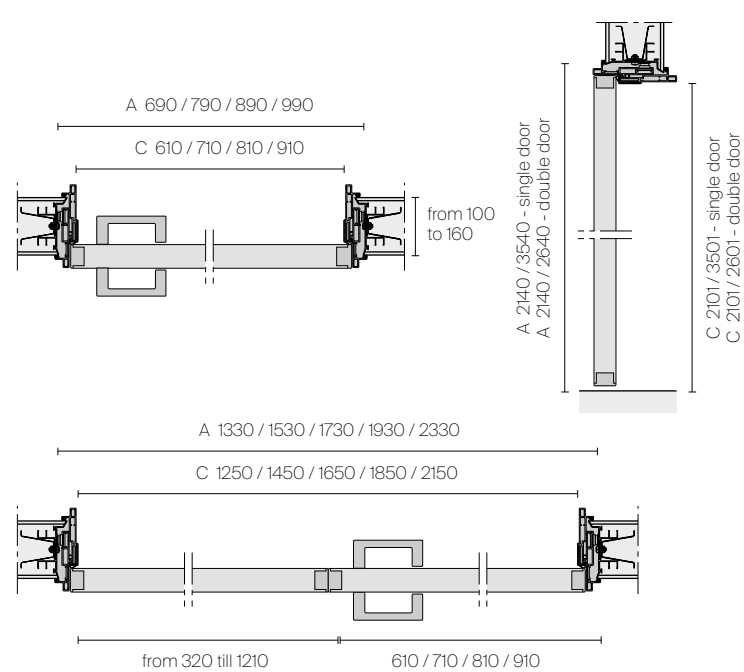
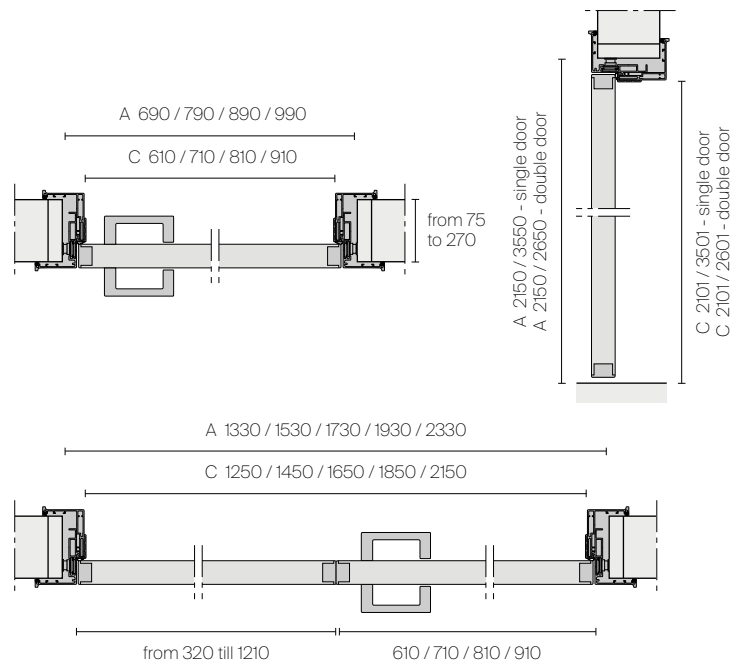
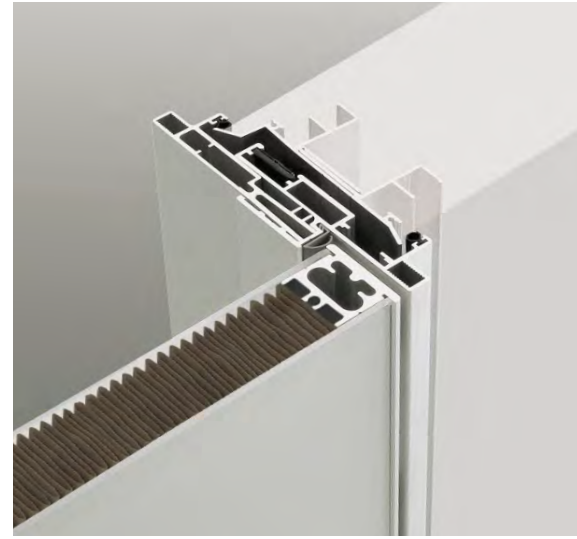

A. Subframe dimension  
C. Opening dimension

POCKET DOOR



SLIM POCKET DOOR FOR SYSTEMS  
SCRIGNO® ESSENTIAL, ECLISSE® SYNTESIS® LINE

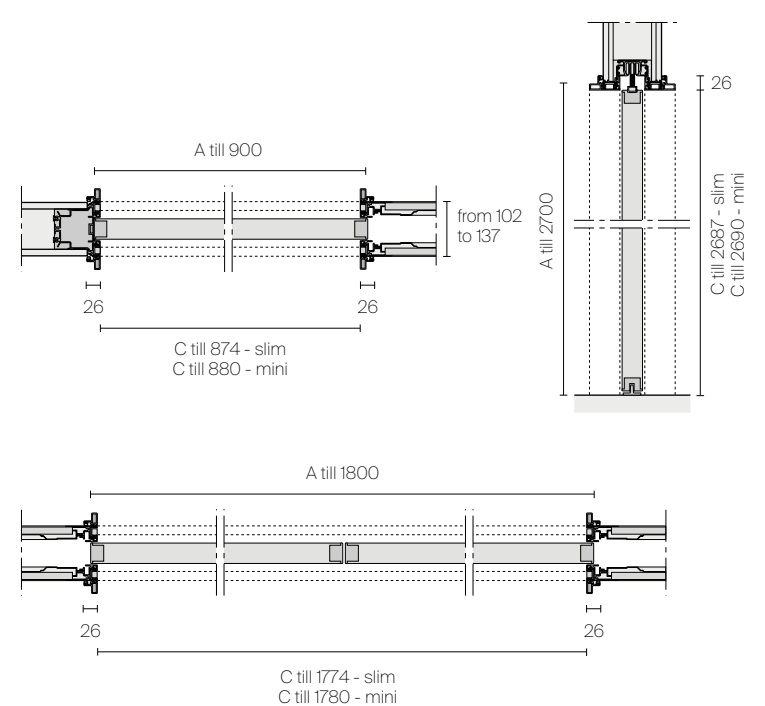
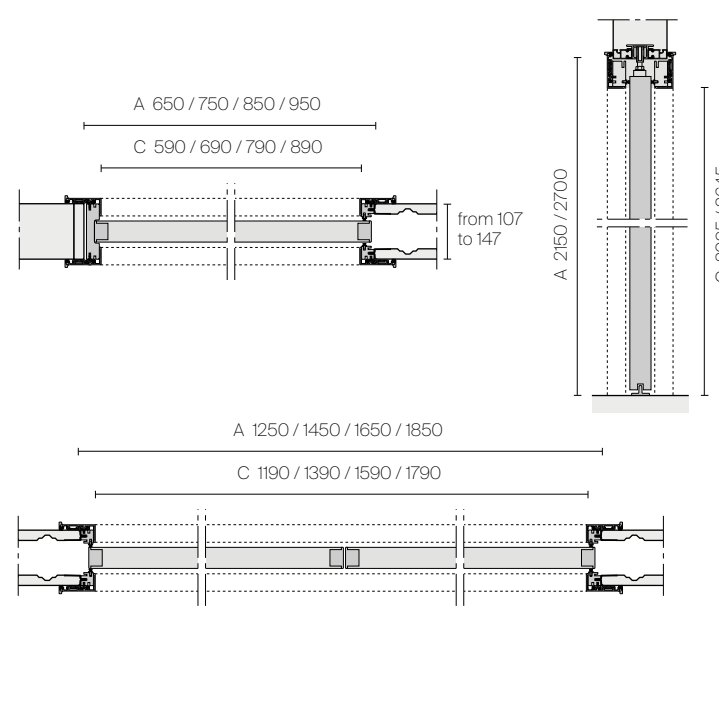
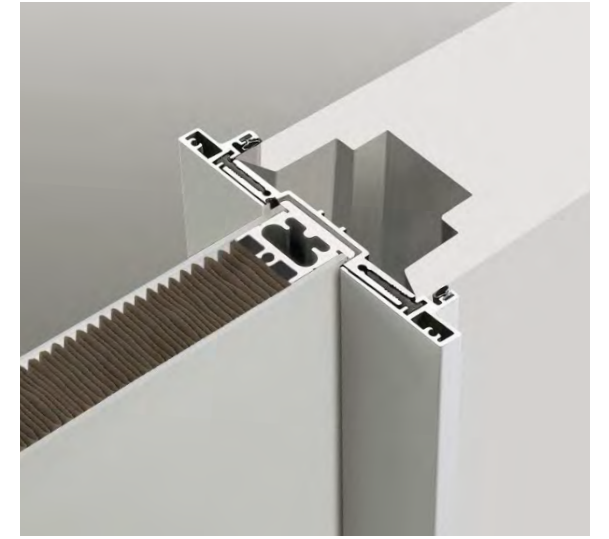

TECHNICAL DESCRIPTION

EN This design features concealed reversible hinges that allow the opening direction to be reversed and guarantee reduced assembly time. The exclusive telescopic aluminium jamb, available on the swing and pocket versions, makes it possible to eliminate differences in wall thickness, also in the slim version.

IT Il progetto è dotato di cerniere reversibili a scomparsa che permettono di invertire il senso di apertura e garantiscono tempi di montaggio ridotti. L'esclusivo stipite telescopico in alluminio, disponibile sulla versione battente e scorrevole, anche nella versione slim, consente di annullare le differenze di spessore fra le pareti.

DE Das Design verfügt über verdeckte, umkehrbare Scharniere, die eine Umkehrung der Öffnungsrichtung ermöglichen und eine reduzierte Montagezeit garantieren. Der einzigartige teleskopische Aluminiumpfosten, der für die Schwing- und Schiebeversion erhältlich ist, auch in der schmalen Version, ermöglicht es, unterschiedliche Wandstärken auszugleichen.

FR Le modèle est doté de charnières réversibles et invisibles qui permettent d'inverser le sens d'ouverture et garantissent des temps de montage réduits. Disponible sur les versions battante et galandage, ainsi que dans la version slim, le montant télescopique exclusif en aluminium permet d'éliminer les différences d'épaisseur entre les murs.

ES El proyecto está equipado con bisagras reversibles ocultas que permiten invertir el sentido de apertura y garantizan tiempos de montaje reducidos. La exclusiva jamba telescópica de aluminio, disponible en las versiones batiente y corredera, también en la versión Slim, permite eliminar las diferencias de espesor entre las paredes.

RU Конструкция оснащена потайными оборачиваемыми петлями, которые позволяют изменять направление открывания и способствуют сокращению времени монтажа. Эксклюзивная телескопическая коробка из алюминия со стандартным или тонким наличником, доступная для распашной или сдвижной версии двери, позволяет устранить разницу в толщине стен.

汉语 这项设计配有隐藏式可逆铰链，功能为将门以相反方向开启，安装更为省时。铰链门、推拉门和 Slim 皆可采用特殊铝制伸缩门套，以消除不同墙面之间的厚度差

DIMENSIONS

Swing door

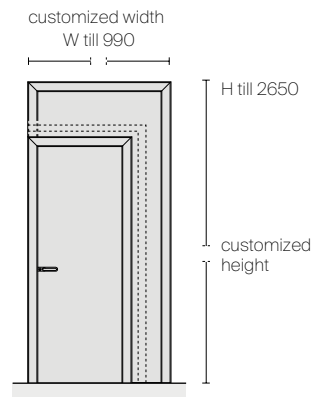

Swing door with fanlight

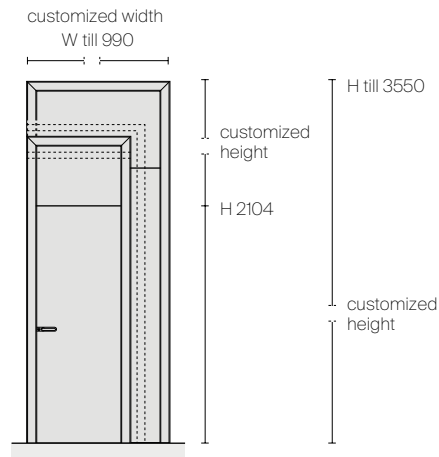

Slim swing door

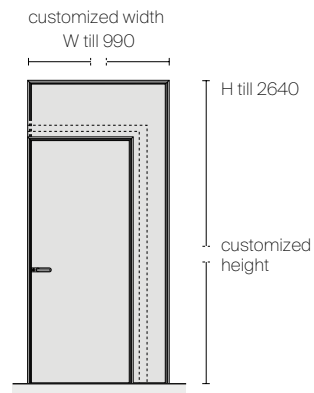

Slim swing door with fanlight

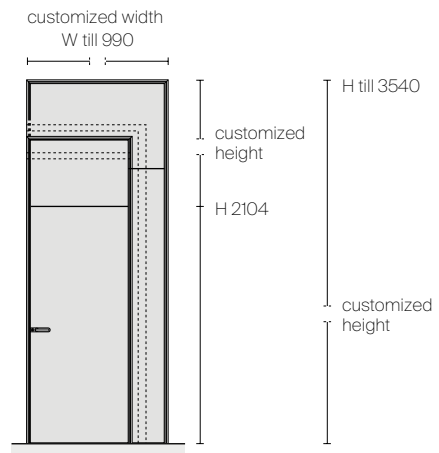

HANDLES



1 2 3



4 5

1. Handle TR03 with lever tumbler / Handle TR03C with key
2. Handle TR02 with lever tumbler / Handle TR02C with key
3. Handle 2097 with lever tumbler
4. Handle 2163 with door pull
5. Handle 2163N with lever tumbler / Handle 2163C with key

FINISHINGS

Structure and handle

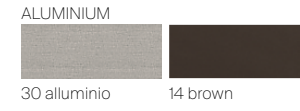
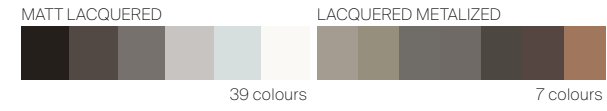

Door panel

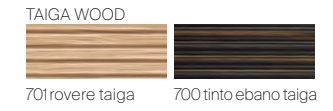
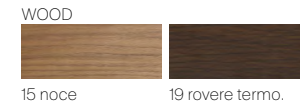
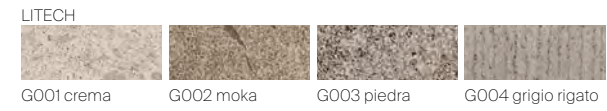
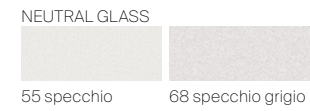
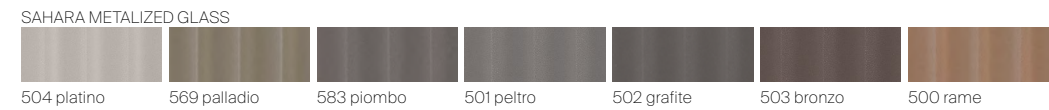
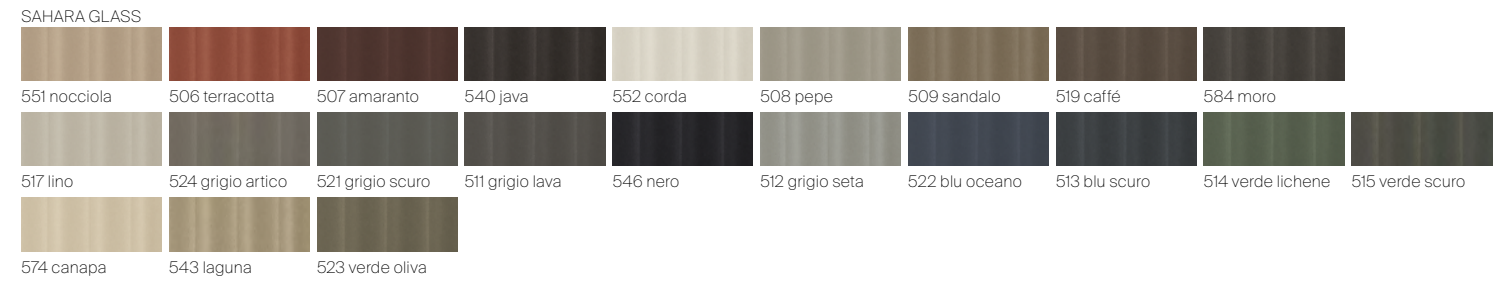



QUALITY AS THE MAIN PURPOSE, ALWAYS AND IN EVERY ASPECT. WITH THIS MISSION RIMADESIO IS CONSTANTLY SEARCHING FOR SOLUTIONS TO IMPROVE ITS OWN ECOLOGICAL STANDARDS.

OBJECTIVE OBTAINED THANKS TO THE USE OF PRECIOUS AND RECYCLABLE MATERIALS, TO THE ABSENCE OF SUBSTANCES THAT CAN BE TOXIC TO HUMANS OR HARMFUL TO THE ENVIRONMENT IN EVERY PHASE OF THE PRODUCTIVE PROCESS, TO THE USE OF TECHNOLOGY AND EVOLVED MACHINERY, POWERED BY CLEAN ENERGY DERIVED FROM PHOTOVOLTAIC SYSTEMS, INSTALLED ON THE GIUSSANO HEADQUARTERS ROOF.

ALUMINIUM, GLASS, WOOD: FULLY RECYCLABLE AND PARTLY ALREADY RECYCLED MATERIALS.

PROOFS OF A REINFORCED GREEN DNA AND WIDE COHERENCE, SIGNALS OF A CONTINUOUS RESEARCH AND A GLANCE TOWARDS THE FUTURE, THAT TAKES SHAPE IN THE TECHNOLOGICAL INNOVATION OF SYSTEMS, DOORS AND FURNITURE, MADE WITH THE AWARENESS OF WANTING TO ENTRUST HUMANS ONLY WITH HIGH VALUE-ADDED ACTIVITIES.

# EXCELLENCE SUSTAINABILITY PROJECT

IT Perseguire la qualità, sempre, sotto tutti gli aspetti. Con questa mission Rimadesio ricerca costantemente soluzioni volte a migliorare i propri standard qualitativi ecologici. Obiettivo ottenuto sinergicamente, grazie all'utilizzo di materiali preziosi e riciclabili, all'assenza di sostanze tossiche per l'uomo e nocive per l'ambiente in ogni fase del processo produttivo, all'impiego di tecnologie e macchinari evoluti alimentati con energia pulita proveniente da impianti fotovoltaici, installati sulla copertura dell'headquarter di Giussano. Alluminio, vetro, legno, materiali totalmente riciclabili e in parte già riciclati, ma anche le vernici prive di solventi di Ecoloursystem e i sistemi di imballaggio ecologici. Testimonianze di un dna green consolidato e di una coerenza trasversale, segnali di una continua attività di ricerca e di uno sguardo sempre proteso al futuro che si declina nell'innovazione tecnologica di sistemi, porte ed arredi, realizzati con la consapevolezza di voler affidare all'uomo solo attività dall'alto valore aggiunto.

DE Stets um Qualität bemüht, und zwar in allen Bereichen. Mit dieser Mission im Blick sucht Rimadesio laufend nach Lösungen, um seine ökologischen Qualitätsstandards zu verbessern. Dieses Ziel wurde dank der Verwendung wertvoller und wiederverwertbarer Materialien, dem Verzicht auf für den Menschen giftige und umweltschädliche Stoffe in jeder Phase des Produktionsprozesses und dem Einsatz fortschrittlicher Technologien und Maschinen, die mit sauberer Energie aus den auf dem Dach des Giussano-Hauptsitzes installierten Photovoltaikanlagen betrieben werden, synergetisch erreicht. Aluminium, Glas, Holz, vollständig recycelbare und teilweise bereits recycelte Materialien, aber auch die lösungsmittelfreien Farben von Ecoloursystem und umweltfreundliche Verpackungssysteme. Ein Zeugnis einer fundierten grünen DNA und einer transversalen Kohärenz, Zeichen einer kontinuierlichen Forschungstätigkeit und eines stets in die Zukunft gerichteten Blicks, der sich in der technologischen Innovation von Systemen, Türen und Einrichtungsgegenständen ausdrückt, die in dem Bewusstsein realisiert werden, den Menschen nur Tätigkeiten mit hohem Mehrwert anzuvertrauen.

FR Poursuivre la qualité, toujours, et à tous les égards. Avec cette mission Rimadesio recherche constamment de solutions au fin d'améliorer ses normes de qualité écologique. Objectif atteint, grâce à l'utilisation de matériaux précieux et recyclables, l'absence à chaque étape de la production de substances toxiques nocives pour l'homme et l'environnement, l'utilisation de technologies et des machines avancées alimentées par l'énergie solaire après l'installation sur le toit de l'usine à Giussano de systèmes photovoltaïques. Aluminium, verre, bois, des matériaux entièrement recyclables et déjà en partie recyclés, mais aussi peinture Ecoloursystem sans solvants et systèmes d'emballage respectueux de l'environnement. Témoignages d'un adn "vert" consolidé et d'une cohérence transversale, signes de recherche continue et d'une tendance à regarder en avant, qui correspond bien à l'innovation technologique des systèmes, des portes et des meubles, réalisés avec la conscience que l'apport de l'homme dans la production ne peut qu'avoir un valeur ajoutée.

ES Perseguir la calidad, siempre, en todos los aspectos. Con esta misión Rimadesio busca constantemente soluciones destinadas a mejorar sus estándares de calidad ecológica. Objetivo conseguido sinérgicamente, gracias al uso de materiales preciosos y reciclables, a la ausencia de sustancias tóxicas para los seres humanos y nocivas para el medio ambiente en cada etapa del proceso de producción, al uso de tecnologías y máquinas avanzadas alimentadas por energía limpia a partir de sistemas fotovoltaicos, instalados en la cobertura del headquarter de Giussano. Aluminio, cristal, madera, materiales completamente reciclables y, en parte, ya reciclados, sino también las pinturas Ecoloursystem libres de disolventes y los sistemas de embalaje ecológicos. Testimonios de un adn green consolidado y una coherencia transversal, señales de una continua investigación y de una vista siempre tendida al futuro que se declina en la innovación tecnológica de sistemas, puertas y muebles, realizados con el conocimiento que desea confiar al hombre sólo actividades de alto valor añadido.

RU Обеспечение качества всегда и во всем. И, в том числе, для достижения этой цели Компания Rimadesio находится в постоянном поиске решений, направленных на улучшение экологических стандартов качества. Эта цель была достигнута благодаря использованию на каждом этапе производственного процесса ценных материалов, пригодных для вторичной переработки, отсутствию токсичных для человека и вредных для окружающей среды веществ, а также благодаря внедрению передовых технологий и оборудования, работающего на чистой энергии от фотоэлектрических систем, установленных на крыше штаб-квартиры компании в г. Джуссано. Компания использует такие материалы, как алюминий, стекло, дерево – полностью перерабатываемые и уже частично переработанные материалы, краски Ecoloursystem, не содержащие растворителей, а также экологически упаковку. Свидетельство консолидированной экологичности и непрерывной последовательности, исследовательской деятельности и взгляда, всегда устремленного в будущее, что выражается в технологических инновациях систем, дверей и мебели, произведенных с осознанием того, что человеку стоит поручать только деятельность с высокой добавленной стоимостью.

汉语 始终至终追求全方位的卓越品质。Rimadesio 肩负使命，不断探索精进生态质量标准的解决方案。品牌目标之达成有赖于珍贵的可回收材料，该材料在所有制造阶段皆不会产生危害人体和环境之有毒物质，同时结合业界前沿的技术以及先进机械装置；而位于朱塞诺 (Giussano) 品牌总部建筑屋顶上的光伏发电设备为上述之机械装置供给干净的能源。除了可完全回收和已部分回收的铝材、玻璃、木材等材料之外，还有环保色彩系统 (Ecoloursystem) 的无溶剂涂料和生态环保型包装。深植的绿色 DNA、跨领域的协同性、持续的研究工作以及具前瞻性的未来展望皆体现在家具系统、各式门类 and 家具配件的技术创新上，其本着信赖人类才能胜任高附加价值活动的意念研发而成。

## GUIDE TO RIMADESIO QUALITY

### TEMPERED GLASSES

Single tempered glasses cooked at a temperature of 650 °C. Mechanical resistance 5 times superior in comparison to a normal glass. In case of breaking it crumbles in harmless tiny fragments. In accordance with the UNI EN 12150, UNI 7697 and UNI EN 12600 rules with reference to the security of glasses for decoration purposes.

### LAMINATED GLASSES

Double glasses. Between the two glasses a thin plastic film is inserted. Transparent and invisible, it perfectly sticks to both surfaces. Both surfaces are perfectly smooth.Resistance to breaking in accordance with the UNI EN ISO 12543, UNI 7697 and UNI EN 12600 rules. The plastic film witholds the fragments in case of breaking.

### GLASS WITH METAL NET AND MESH

Double laminated glasses. Between the two extra-clear glasses and two thin plastic films a micronet fabric is inserted. Through a sophisticated process a metal layer is applied on the fabric, thus creating a characteristic effect of semi transparency. The reflections of the light on the surface of the metallic net are provided by using an extra-clear float glass, which allows maximum transparency and high light transmissions, thanks to the low content of iron oxides. Following the process of hot stratification, the fabric might show minor wave effect, which give the material its characteristic materic and natural look.

### ECOLORSYSTEM LACQUERED GLASSES

Ecolorsystem is the name that distinguishes the exclusive Rimadesio lacquered glass collection in glossy and matt finishing. Ecological colours produced using exclusively water paints of latest generation, cooked at 110° C. A production technology in the area of glass, with a fully robotised in-house plant that ensures very high quality results and a low environmental impact work cycle. Corrosion resistance conforms to the UNI EN ISO 9227 standard. Temperature fluctuation resistance conforms to the UNI 9429 standard. The colour is inside the double glass, safe from stains, dust and humidity. The thickness of the glass creates an exclusive "depth" effect.

### VETRI TEMPERATI

Vetri singoli, sottoposti al trattamento della tempra ovvero ad una cottura alla temperatura di 650 °C. Resistenza meccanica di 5 volte superiore rispetto ad un vetro normale. In caso di rottura si sbriciola in minuti frammenti inoffensivi. Conformi alle norme UNI EN 12150, UNI 7697 e UNI EN 12600 in materia di sicurezza per i vetri d'arredamento.

### VETRI STRATIFICATI

Vetri doppi. Fra i due vetri è inserita una sottile pellicola di materiale plastico, trasparente ed invisibile, che aderisce completamente alle due superfici. Entrambe le superfici sono perfettamente lisce. Resistenza alla rottura conforme alle norme UNI EN ISO 12543, UNI 7697 e UNI EN 12600. La pellicola di materiale plastico in caso di rottura trattiene i frammenti.

### VETRI STRATIFICATI RETE, MAGLIA E FIBRA

Vetri doppi stratificati. Tra i due vetri extra-chiari e le due sottili pellicole in materiale plastico, è inserito un tessuto in microrete sul quale, tramite un sofisticato processo di materizzazione, viene depositato uno strato metallico che crea un caratteristico effetto di semitrasparenza. Le riflessioni della luce sulla superficie della rete metallizzata sono ottenute con l'utilizzo del vetro float extrachiario che, grazie al basso contenuto di ossidi di ferro, garantisce la massima trasparenza e un'elevata trasmissione luminosa. Il tessuto, a seguito del processo di stratifica a caldo, può presentare delle leggere ondulazioni che conferiscono al materiale il suo caratteristico aspetto materico e naturale.

### VETRI LACCATI ECOLORSYSTEM

Ecolorsystem è la denominazione che contraddistingue l'esclusiva collezione di vetri laccati Rimadesio, disponibili in finitura lucida e opaca. Colori ecologici perché prodotti utilizzando esclusivamente vernici all'acqua di ultima generazione, con cottura a 110°C. Una tecnologia produttiva all'avanguardia nell'ambito del vetro, con impianti interni totalmente robotizzati che assicurano risultati di altissima qualità e un ciclo di lavorazione a basso impatto ambientale. Resistenza alla corrosione conforme alla norma UNI EN ISO 9227. Resistenza agli sbalzi di temperatura conforme alla norma UNI 9429. Colori inalterabili nel tempo perché applicati sulla superficie interna del vetro, al sicuro da macchie, polvere e umidità. Lo spessore del vetro crea un esclusivo effetto di "profondità".

### TEMPERIERTES GLAS

Einzelgläser, die einer Härtingsbehandlung oder einer Kochtemperatur von 650 °C unterzogen wurden. Mechanische Beständigkeit 5 mal höher als bei normalem Glas. Im Bruchfall zerbröckeln harmlose Bruchstücke in Minuten. Entspricht den Normen UNI EN 12150, UNI 7697 und UNI EN 12600 für die Sicherheit von Möbelgläser.

### SCHICHTGLAS

Doppelgläser. Zwischen den beiden Gläsern befindet sich ein dünner Film aus transparentem und unsichtbarem Kunststoff, der vollständig an den beiden Oberflächen haftet. Beide Oberflächen sind komplett glatt. Die Bruchfestigkeit entspricht den Normen UNI EN ISO 12543, UNI 7697 und UNI EN 12600. Die Kunststoffolie bewahrt im Bruchfall die Bruchstücke.

### SCHICHTGLAS MIT METALLNETZ, GLASGITTER UND FASER

Hierbei handelt es sich um Doppel-schichtgläser. Zwischen den zwei Extralight-Glasscheiben und den beiden unsichtbaren Plastikfolien wird ein Metall-netz eingesetzt. Das kreiert einen besonderen halbtransparenten Effekt. Der Wiederschein des Lichtes auf der Oberfläche des Metallnetzes wird durch die Verwendung von Extralight Float Glas erzielt. Dank eines kleinen Anteils von Eisenoxid haben wir die maximale Lichtdurchlässigkeit und eine sehr hohe Lichtübertragung erzielen können. Das Netz kann nach dem unter Hitze durchgeführten Schichtungsverfahren leichte Welle aufweisen, was dem Material ein natürliches Aussehen verleiht.

### LACKIERTE GLÄSER ECOLORSYSTEM

Ecolosystem ist der Name der lackierten Glas-Kollektion von Rimadesio in der glänzend und matte Ausführung verfügbar. Absolut oekologische Farben, da die modernsten Lackierungen, auf Wasser-Basis, an einer Temperatur von 110° gekocht werden. Eine fortschrittliche Produktionstechnik in der Glasverarbeitung auf einer vollautomatisierten Anlage, die Ergebnisse höchster Qualität und gleichzeitig umweltfreundliche Verarbeitungsverfahren gewährleistet. Korrosion-sprüfung gemäß Bestimmung UNI EN ISO 9227. Temperaturwechselprüfung gemäß Bestimmung UNI 9429. Unverändliche Farben da die Farbung sich im Innen des Doppelglases, geschützt vor Staub, Kratzen und Feuchtigkeit, befindet. Die Dicke des Glases erzeugt eine einzigartige Tiefwirkung.

### VERRES TREMPÉS

Verres simples, soumis au traitement de trempe et donc à une température de cuisson de 650 °C. Résistance mécanique 5 fois supérieure à celle du verre normal. En cas de rupture, des fragments inoffensifs s'effritent en quelques minutes. Conforme aux normes UNI EN 12150, UNI 7697 et UNI EN 12600 pour la sécurité des verres pour les meubles.

### VERRES STRATIFIÉS

Double verres. Entre les deux verres se trouve une fine pellicule de matière plastique, transparente et invisible, qui adhère complètement aux deux surfaces. Les deux surfaces sont parfaitement lisses. La résistance aux ruptures est conforme aux normes UNI EN ISO 12543, UNI 7697 et UNI EN 12600. La pellicule retient les fragments en cas de rupture.

### VERRE FEUILLETÉ AVEC NET, MAILLE ET FIBRA

Double verre stratifié. Entre les deux verres extra clair et les deux films fins de matière plastique un tissu en micro maille est ajouté. A travers un procédé avancé de materisation un couche métallique est déposé sur ce tissu, créant un effet caractéristique translucide. Les reflets de la lumière sur la surface de la maille métallique sont obtenus avec l'utilisation du verre float extra clair, qui, grâce à un faible teneur de oxydes de fer, permet un maximum de transparence et de transmission de la lumière. Suite au procédé de stratification à chaud, le tissu peut présenter de petites ondulations, qui apportent au matériau son aspect caractéristique et naturel.

### VERRES LAQUÉS ECOLORSYSTEM

Ecolorsystem est le nom qui caractérise la collection exclusive de verres laqués de Rimadesio disponibles en finition brillante et mate. Couleurs écologiques, parce que produits en utilisant exclusivement vernis à l'eau de dernière génération, cuites à 110°. Une technologie de production avant-gardiste dans le domaine du verre, avec des équipements internes entièrement robotisés qui assurent des résultats de grande qualité et un cycle de production ayant un impact très faible sur l'environnement. Résistance à la corrosion conformément à la norme UNI EN ISO 9227. Résistance aux écarts de température conformément à la norme UNI 9429. Couleurs inaltérables parce qu'ils sont appliqués dans la surface interne du verre, pour protéger de la poussière humidité et taches. L'épaisseur du verre crée un exclusif effet profondeur.

### CRISTALES TEMPLADOS

Vidrios simples, sometidos al tratamiento de templado a una temperatura de cocción de 650 °C. Resistencia mecánica de 5 veces mayor que el vidrio normal. En caso de rotura, se desmoronan fragmentos inofensivos. Conforme a las normas UNI EN 12150, UNI 7697 y UNI EN 12600 en materia de seguridad para los cristales en el amueblamiento.

### CRISTALES ESTRATIFICADO

Vidrios dobles. Entre los dos vidrios hay una película fina de material plástico, transparente e invisible, que se adhiere completamente a las dos superficies. Ambas superficies son perfectamente lisas. La resistencia a la rotura cumple con las normas UNI EN ISO 12543, UNI 7697 y UNI EN 12600. La película de plástico en caso de rotura retiene los fragmentos.

### CRISTALES ESTRATIFICADOS RED METÁLICA, MAILLA Y FIBRA

Cristales dobles estratificados. Entre los dos cristales extraclaros y las dos capas sintéticas, está inserido en un tejido de microred en el que, a través de un sofisticado proceso se deposita una característica de efecto semitransparente. Los reflejos de la luz sobre la superficie de la red metálica se proporcionan con el uso del vidrio float extraclaro que, gracias a su bajo contenido en óxidos de hierro, asegura la máxima transparencia y una alta transmisión de luz. El tejido, siguiendo el proceso de estratificación en caliente, puede presentar ligeras ondulations que dan al material su aspecto característico natural.

### CRISTALES LACADOS ECOLORSYSTEM

Ecolorsystem es la denominación que marca la exclusiva colección de los cristales lacados Rimadesio, disponibles en acabado brillante y mate. Colores ecológicos porque productos utilizando exclusivamente pinturas al agua de última generación, con cocción a 110°. Una tecnología productiva a la vanguardia en el ámbito del cristal, con unas instalaciones internas totalmente robotizadas que aseguran resultados de altísima calidad y un ciclo de tratamiento respetuoso del medio ambiente. Resistencia a la corrosión conforme a la norma UNI EN ISO 9227. Resistencia a las variaciones de temperatura conforme a la norma UNI 9429. Colores inalterables en el tiempo porque aplicados en la superficie interior del cristal, al resguardo de manchas, polvo y humedad. El grosor del cristal crea un exclusivo efecto de "profundidad".

### ЗАКАЛЕННОЕ СТЕКЛО

Механическая прочность одинарных стекол, подвергнутых закалке, т.е. обжигу при температуре 650°С, в 5 раз выше, чем у обычного стекла. Если такое стекло разбить, оно рассыпется на мелкие неопасные осколки. Соответствует стандартам безопасности UNI EN 12150, UNI 7697 и UNI EN 12600 для мебельного стекла.

### МНОГОСЛОЙНОЕ СТЕКЛО

Двойные стекла. Тонкая, прозрачная и невидимая пластиковая пленка прокладывается между двумя стеклами и полностью приклеивается к обеим поверхностям. Обе поверхности идеально гладкие. Проверка прочности на разрыв была выполнена в соответствии со стандартами UNI EN ISO 12543, UNI 7697 и UNI EN 12600. Эта пленка способна удерживать осколки разбившегося стекла.

### МНОГОСЛОЙНОЕ СТЕКЛО, СТЕКЛО С СЕТКОЙ

Многослойное двойное стекло. Между двумя сверхпрозрачными стеклами и двумя тонкими пластиковыми пленками вставляется микросетчатое полотно, на которое в ходе сложного производственного процесса наносится металлический слой, благодаря чему и формируется характерный полупрозрачный эффект. Отражение света на поверхности металлизированной сетки достигается за счет использования сверхчистого флот-стекла, которое из-за низкого содержания оксида железа гарантирует максимальную прозрачность и высокую светопропускную способность. В результате процесса наслаивания в горячем виде полотно приобретает небольшие волнистости, которые придают материалу характерную текстуру и натуральный вид.

### ЛАКИРОВАННОЕ СТЕКЛО

### ECOLORSYSTEM

Ecolorsystem — это название эксклюзивной коллекции лакированного стекла Rimadesio, доступной в глянце-вой и матовой отделке. Коллекция характеризуется мягкими спокойными цветами, поскольку при их производстве используются только краски последнего поколения на водной основе, запекаемые при температуре 110°С. В стекольной промышленности в настоящее время внедряются современные производственные технологии, полностью роботизированные заводы, обеспечивающие высокое качество и незначительное воздействие на окружающую среду. Коррозионная стойкость соответствует требованиям положений стандарта EN ISO 9227. Устойчивость к изменениям температуры соответствует требованиям стандарта UNI 9429. Цвет характеризуется исключительной долговечностью, поскольку краски наносятся на внутреннюю поверхность стекла, защищенную от пятен, пыли и влаги. Толщина стекла создает уникальный эффект «глубины».

钢化玻璃 单片玻璃通过淬火工艺,即经 650 °C 高温烧制而成,其机械阻力相较于普通玻璃高出 5 倍。钢化玻璃破裂时会碎成不易伤人的细小碎片。符合家具玻璃安全材质 UNI EN 12150、UNI 7697 以及 UNI EN 12600 的标准。

### 夹层玻璃

双层玻璃。在两片玻璃之间夹有一层纤薄、透明、无形的塑料薄膜,其完全贴合两片玻璃的表面。两片玻璃的表面皆光滑无比。其抗裂性能符合 UNI EN ISO 12543、UNI 7697 以及 UNI EN 12600 的标准。玻璃破裂时,其碎片会粘在塑料薄膜上,裂而不散。

### 网夹层玻璃、网格夹层玻璃和纤维夹层玻璃

双层夹层玻璃。在两片超清玻璃和两层纤薄的塑料薄膜之间夹入一层微型网状织 物,一道细腻的材质加工工艺,会在织物上覆盖一层金属并创造 出半透明的特殊效果。使用超清浮法玻璃产出金属网表面的光线反射,因玻璃的氧化铁含量低,可确保最大透明度和高透光率。通过热分层加工工艺,夹入的织物会有不平整的现象,从而呈现出具有特色的材质纹理和自然感的外观。

### 环保色彩系统 (Ecolorsystem) 的烤漆玻璃

Ecolorsystem 为 Rimadesio 烤漆玻璃独家系列的名称,有亮面和哑光两种表面处理可供选择。由于仅使用最新一代的水性涂料搭配 110°C 烘烤工序完成而被称为生态环保性色彩;其为超前玻璃业界的生产技术,而全机器人化的内部设备确保极高的产品质量和低环境冲击的加工循环。其抗腐蚀程度符合 UNI EN ISO 9227 的标准。其抗温度急变性符合 UNI 9429 的标准。因色彩涂层夹于玻璃内层,因此不会褪色且不受脏污、灰尘和湿气的影 响。玻璃的厚度创造出一种独特的“深度”效果。

ECOLORSYSTEM LACQUERED GLASS

GLOSSY MATT		GLOSSY MATT		GLOSSY MATT		GLOSSY MATT		GLOSSY MATT		GLOSSY MATT			
305	138 cipria	45	97 avorio	59	105 grigio chiaro	40	115 grigio cenere	53	95 bianco neve	50	108 bianco latte		
51	113 nocciola	52	107 corda	56	98 lino	312	145 grigio seta	47	96 grigio perla	78	114 sabbia		
306	139 terracotta	85	130 tufo	310	143 creta	38	121 azzurro cera	36	117 blu Londra	74	110 canapa		
76	116 rosso india	308	141 pepe	317	600 grigio artico	35	100 blu notte	39	122 verde inglese	73	109 giallo kashmir		
75	129 amaranto	309	142 sandalo	88	132 grigio scuro	86	131 blu oceano	314	147 verde lichene	43	119 laguna		
307	140 java	58	99 caffè	311	144 grigio lava	313	146 blu scuro	315	148 verde scuro	33	111 verde oliva		
		84	128 moro	46	102 nero					316	149 verde terra		

ECOLORSYSTEM SAHARA GLASS

551	nocciola sahara	552	corda sahara	517	lino sahara	512	grigio seta sahara	514	verde lichene sahara	574	canapa sahara
506	terracotta sahara	508	pepe sahara	524	grigio artico sahara	522	blu oceano sahara	515	verde scuro sahara	543	laguna sahara
507	amaranto sahara	509	sandalo sahara	521	grigio scuro sahara	513	blu scuro sahara			523	verde oliva sahara
540	java sahara	519	caffè sahara	511	grigio lava sahara						
		584	moro sahara	546	nero sahara						

ECOLORSYSTEM TAIGA GLASS

851	nocciola taiga	852	corda taiga	817	lino taiga	812	grigio seta taiga	814	verde lichene taiga	874	canapa taiga
806	terracotta taiga	808	pepe taiga	824	grigio artico taiga	822	blu oceano taiga	815	verde scuro taiga	843	laguna taiga
807	amaranto taiga	809	sandalo taiga	821	grigio scuro taiga	813	blu scuro taiga			823	verde oliva taiga
840	java taiga	819	caffè taiga	811	grigio lava taiga						
		884	moro taiga	846	nero taiga						

ECOLORSYSTEM METALIZED GLASS

GLOSSY MATT		SAHARA		TAIGA		DIAMANTE	
304	137 platino	504	platino sahara	804	platino taiga	404	platino diamante
69	126 palladio	569	palladio sahara	869	palladio taiga	469	palladio diamante
83	127 piombo	583	piombo sahara	883	piombo taiga	483	piombo diamante
301	134 peltro	501	peltro sahara	801	peltro taiga	401	peltro diamante
302	135 grafite	502	grafite sahara	802	grafite taiga	402	grafite diamante
303	136 bronzo	503	bronzo sahara	803	bronzo taiga	403	bronzo diamante
300	133 rame	500	rame sahara	800	rame taiga	400	rame diamante

NEUTRAL GLASS

55	specchio
68	specchio grigio

TRANSPARENT GLASS

890	trasparente taiga
590	trasparente sahara
490	trasparente diamante
05	trasparente extrachiaro
00	trasparente
63	grigio trasparente
65	bronzo trasparente
390	verde trasparente
391	blu trasparente

SATINATED GLASS

67	riflettente chiaro
64	riflettente grigio
81	riflettente bronzo
891	acidato taiga
591	acidato sahara
02	acidato extrachiaro
01	acidato
03	acidato grigio
04	acidato bronzo
82	nuvola extrachiaro
80	nuvola

MESH GLASS

60	rete alluminio
61	rete inox
62	rete bronzo
66	maglia gold
87	maglia rame
06	fibra argento
08	fibra bronzo

REFLEX GLASS

90	bianco reflex
92	kaki reflex
94	cacao reflex
89	nero reflex

## GUIDE TO RIMADESIO QUALITY

<b>ALUMINIUM</b>	<b>LEATHER</b>
<b>POWDER LACQUERED FINISHING</b> Detachment resistance of the layer of powder paint conforms to the norm. Corrosion resistance of the powder paint conforms to Machu test results and to the norm. Fingerprint resistance of the powder paint conforms to the norm.	Real bovine natural leather obtained by a process of tanning. The surface is polished to obtain the different colours of the collection.
<b>GLOSSY ALUMINIUM FINISHING</b> The glossy aluminium is realized through the procedure of scraping and polishing of the aluminium, both artisanal processes carried out through last generation plants.	<b>ALLUMINIO</b>
	<b>FINITURA ANODIZZATA</b> Resistenza all'abrasione della finitura anodizzata conforme alla norma. Resistenza alla corrosione della finitura anodizzata conforme alla norma.

**NICKEL GRIGIO FINISHING**  
The nickel grigio finishing is obtained through several painting layers with the latest generation of enamels, capable of creating the appearance of the most natural metal oxidations. The special glossy effect is the result of a manual brushing and polishing process carried out on the raw material.

**ANODIZED FINISHING**  
Abrasion resistance of the anodised finish conforms to the norm. Corrosion resistance of the anodised finishing conforms to the norm.

**WOOD**  
Veneered elements, such as tops, cabinets and shelves, are produced by using materials in compliance with current regulations concerning the emissions of formaldehyde. Open pore painting with primer and non-toxic matt transparent acrylic finishing.

**LITECH**  
Litech is a compact, hard, coloured and non-porous ceramic material, obtained through a mixture of clays, sand and other natural substances, that cooked at a high temperature (1000-1300 °C). The exclusive controlled intensity variation weave, created with the most innovative molding techniques with water-based ecologic and sustainable inks and enamels. High resistance to abrasion.

**MATERIAL FABRIC**  
Italian handcraft fabric made of: viscose 43%, cotton 36%, polyester 15%, linen 6%. Resistance to scraping, Martindale test 25,000 twists. Resistance to pilling, class 4. Resistance to discolouration, Xenotest class 5. Conforms to BS 5852-1979 part 0 cigarettes test.

**LUX FABRIC**  
Italian handcraft fabric made of: cotton 75%, silk 25%. Lux fabric is a sustainable and environmentally friendly material with recycled cotton fibers and biodegradable silk.

**TECH FABRIC**  
Italian handcraft fabric made of: polyester 100% Trevira CS. Resistance to scraping, Martindale test 75,000 twists. Resistance to pilling, class 5. Resistance to discolouration, Xenotest class 5/6 Conforms to BS 5852:2006 Source 5 CRIB 5, BS 5852:1990 sez.4 part.1 cigarette test.

**SYNTHETIC LEATHER**  
Latest generation material entirely produced in Italy and animal-derived components free, made of: polyester 8%, polyurethane 4%, pvc 88%, textile composition: polyester 100%. It is an exclusive by Rimadesio, resistant and high performing, it is also ortho- phthalates free, in accordance with the European Reach regulation for the protection of human health and the environment from the risks of chemical substances. The production system of Rimadesio synthetic leather complies with current environmental and quality standards.

<b>ALLUMINIO</b>	<b>FINITURA LACCATA A POLVERE</b>
	Resistenza al distacco dello strato di vernice a polvere conforme alla norma. Resistenza alla corrosione della vernice a polvere conforme ai risultati del Machu Test e alla norma. Resistenza all'impronta della vernice a polvere conforme alla norma.
	<b>FINITURA ALLUMINIO LUCIDO</b> L'alluminio lucido viene realizzato mediante la spazzolatura e la brillantatura dell'alluminio, entrambi processi artigianali eseguiti tramite impianti di ultima generazione.
	<b>FINITURA NICKEL GRIGIO</b> La finitura nickel grigio viene ottenuta mediante diversi passaggi di verniciatura con smalti di ultima generazione, in grado di conferire l'aspetto delle più naturali ossidazioni metalliche. Lo speciale effetto lucido è il risultato di un processo manuale di spazzolatura e brillantatura effettuato sul materiale grezzo.

<b>ESSENZE</b>	<b>GLÄNZENDES ALUMINIUM-FINISH</b>
Gli elementi impiallacciati, come piani, contenitori e ripiani, sono realizzati utilizzando tranciato conforme alle normative riguardanti le emissioni di formaldeide. Verniciatura a poro aperto con fondo e finitura acrilica atossica opaca trasparente.	Polieries Aluminium wird durch Bürsten und Polieren von Aluminium erreicht, wobei beide handwerklichen Verfahren durch die neuesten Energieerzeugungssysteme ausgeführt werden.
	<b>NICKEL GRIGIO-FINISH</b> Das Nickel grigio wird durch mehrere aufeinanderfolgende Lackierungsvorgänge geschafft. Dazu werden Lacke der neuesten Generation verwendet, die das Aussehen der natürlichsten Metalloxidation verleihen. Der besondere Glanzeffekt wird durch einen manuellen Vorgang von Bürsten und Schleifen auf dem Rohmaterial erreicht.

**HOLZ**  
Die furnierten Elemente wie Sockelböden, Korpusse und Fachböden werden mit Furnier hergestellt, welches den Normen zum Formaldehydausstoß entspricht. Offenporige Lackierung auf Wasserbasis und mit ungiftigem, transparenten Acryllack.

**TESSUTO MATERIAL**  
Tessuto prodotto artigianalmente in Italia, composto da: viscosa 43%, cotone 36%, poliestere 15%, lino 6%. Resistenza all'abrasione, test Martindale 25.000 giri. Resistenza al pilling, classe 4. Resistenza allo scolorimento, Xenotest classe 5. Conforme alla normativa BS 5852-1979 part 0 cigarettes test.

**TESSUTO LUX**  
Tessuto prodotto artigianalmente in Italia, composto da: cotone 75%, seta 25%. Il tessuto Lux è un materiale sostenibile ed ecologico con fibre di cotone riciclato e di seta biodegradabili.

**TESSUTO TECH**  
Tessuto prodotto artigianalmente in Italia, composto da: poliesteri 100% Trevira CS. Resistenza all'abrasione, test Martindale 75.000 giri. Resistenza al pilling, classe 5. Resistenza allo scolorimento, Xenotest classe 5/6 Conforme alle normative BS 5852:2006 Source 5 CRIB 5, BS 5852:1990 sez.4 part.1 cigarette test.

**SIMILPELLE**  
Materiale di ultima generazione realizzato interamente in Italia e privo di componenti di origine animale, composto da: poliesteri 8%, poliuretatica 4%, pvc 88%, composizione tessile: poliesteri 100%. Prodotto esclusivo Rimadesio,

resistente e altamente performante, privo di orto-ftalati, in linea con il regolamento europeo Reach per la protezione della salute e dell'ambiente dai rischi delle sostanze chimiche. Ogni fase di produzione della similpelle Rimadesio è conforme alle normative vigenti in materia ambientale e di gestione della qualità.

**CUOIO**  
Vero cuoio bovino naturale, ricavato tramite processo di concia. La superficie viene verniciata per ottenere le varie colorazioni a catalogo.

<b>ALUMINIUM</b>	<b>STOFF TECH</b>
	In Italien handwerklich produzierte Stoffe die sich aus 100% Polyester Trevira CS zusammensetzen. Korrosionsprüfung: Martindale Test auf 75.000 Touren Pillingstest: Klasse 5. Verfärbungsprüfung: Xenotest Klasse 5/6. Gemäß Norm BS 5852:2006 Quelle: 5 CRIB 5, BS 5852:1990 Sektion 4 TeilI Zigarettentest.
	<b>KUNSTLEDER</b> Vollständig in Italien hergestelltes hochmodernes Material ohne Bestandteile tierischen Ursprungs, bestehend aus: 8% Polyester, 4% Polyurethan, 88% PVC; Textilzusammensetzung: 100% Polyester. Dies ist ein exklusives, widerstandsfähiges und leistungsstarkes Rimadesio Produkt, das gemäß der europäischen Reach-Verordnung keine Ortho-Phthalate enthält. Dies dient zum Schutz der Gesundheit und Umwelt vor den Risiken chemischer Substanzen. Jede Stufe der Kunstlederproduktion von Rimadesio entspricht den geltenden Umwelt- und Qualitätsmanagement Vorschriften.
	<b>LEDER</b> Echtes Rindleder, erhalten durch einen Bräunungsprozess. Die Oberfläche ist lackiert, um die verschiedenen Farben im Katalog zu erhalten.

**ALUMINIUM**  
FINITION ANODISÉE  
Résistance à l'abrasion de la finition anodisée est conforme à la norme.  
Résistance à la corrosion de la finition anodisée est conforme à la norme.

**FINITION LAQUÉE À POWDRE**  
Résistance au décollement de la couche de peinture conforme à la norme.  
Résistance à la corrosion de la peinture à poudre conforme au Machu test et à la norme.  
Résistance à l'empreinte de la peinture à poudre conforme à la norme.

**FINITION ALUMINIUM POLI**  
L'aluminium poli est réalisé par le rayure et polissage de l'aluminium, deux procédés artisanaux réalisés par des équipements de dernière génération.

**FINITION NICKEL GRIGIO**  
La finition en nickel grigio est obtenue grâce à plusieurs passages de peinture réalisés avec les émaux de dernière génération, capables de donner une apparence naturelle des oxydations métalliques. L'effet brillant spécial est le résultat d'un processus de brossage et de polissage manuel effectué sur la matière première.

**BOIS**  
Les éléments de placage, comme les plateaux, les conteneurs et les étagères, sont produits avec un tranchage conforme aux normes concernantes les émissions de formaldéhyde. Verni à pores ouverts avec un apprêt à base d'eau non toxique et finition acrylique mate et transparent.

**STOFF MATERIAL**  
In Italien handwerklich produzierte Stoffe die sich aus 43% Viskose, 36% Baumwolle, 15% Polyester und 6% Leinen zusammensetzen. Korrosionspruefeung, Martindale Test 25.000 Touren. Pillingstest, Klasse 4. Verfaerbungspruefung, Xenotest Klasse 5. Gernaess Norme BS 5852-1979 part 0 cigarettes test.

**STOFF LUX**  
In Italien handwerklich produzierte Stoffe die sich aus 75% Baumwolle, 25% Seide. Lux Stoff ist ein nachhaltiges und umweltfreundliches Material aus

rezyklierten Baumwollfasern und biologisch abbaubaren Seide.

**TISSU TECH**  
Tissu fabriqué à la main en Italie et composé de: 43% viscose; 36% coton; 15% polyester; 6% lin. Résistance à l'abrasion, test Martindale 25.000 rpm. Résistance Pilling, classe 4. Résistance à la décoloration, classe 5 Xenotest. Conformément à la législation BS 5852-1979 Partie 0, cigarettes test.

**TISSU LUX**  
Tissu fabriqué à la main en Italie et composé de: 75% coton; 25% soie. Le tissu Lux est un matériau durable et écologique composé de coton recyclé et de fibres de soie biodégradables.

**TISSU TECH**  
Tissu fabriqué à la main en Italie et composé de: 100% Polyester Trevira CS Résistance à l'abrasion, test Martindale 75.000 rpm. Résistance Pilling, classe 5. Résistance à la décoloration, classe 5/6 Xenotest. Conformément à la législation BS 5852:2006 Source 5 CRIB 5, BS 5852:1990 sez.4 part 1 cigarettes test.

**SIMILICUIR**  
Matériel de dernière génération entièrement réalisé en Italie et sans aucun élément d'origine animale, composé de polyester 8%, polyuréthane 4%, pvc 88%, composition textile: polyester 100%. Produit exclusif Rimadesio, résistant et très performant, sans orthophthalates, conformément au Règlement européen Reach pour la protection de la santé et de l'environnement des risques causés par les substances chimiques.

Eachue fase de production du similicuir Rimadesio se conforme aux réglementations environnementales en vigueur et de gestion de la qualité.

**ACABADO ANODIZADO**  
Resistencia a la abrasión del acabado anodizado cumple con la norma.  
Resistencia a la corrosión del acabado anodizado cumple con la norma.

**ACABADO LACADO EN POLVO**  
Resistencia al desprendimiento de la capa de laca en polvo cumple con la norma.  
Resistencia a la corrosión de la laca en polvo conforme con los resultados de la prueba del Machu Test y con la norma.  
Resistencia a la impresión de la laca en polvo cumple con la norma.

**ACABADO DE ALUMINIO BRILLANTE**  
El aluminio pulido se produce mediante rayadura y pulido de aluminio, ambos procesos artesanales realizados por medio de sistemas de última generación.

**ACABADO DE NICKEL GRIGIO**  
El acabado nickel grigio se obtiene mediante varios pasos de pintura con esmaltes de última generación, sarapes de dar el aspecto de las más naturales oxidaciones de metales. El efecto brillante especial es el resultado de un proceso de cepillado manual y pulido realizado sobre la materia prima.

**MADERA**  
Los elementos chapados de madera, como encimeras, contenedores y estantes, se realizan utilizando hojas conforme a las normas sobre las emisiones de formaldehido. Pintura de poro abierto con imprimación a base de agua y acabado acrílico mate transparente atóxico.

**LITECH**  
El Litech porcelánico es una cerámica de pasta compacta y dura,no porosa y se obtiene con masas de arcillas, arena y otras sustancias naturales cocidas a alta temperatura (1000-1300 °C). La exclusiva textura es creada con las técnicas más innovadoras de moldeo con tintas y esmaltes al agua, ecológicos y sostenibles. Alta resistencia a la abrasión.

**TEJIDO MATERIAL**  
Tejido producido artesanalmente en Italia, compuesto por: viscosa 43%, algodón 36%, poliéster 15%, lino 6%. Resistencia a la abrasión, Martindale prueba de 25.000 rpm. Resistencia al pilling, clase 4. Resistencia a la decoloración, Xenotest clase 5. Conforme a la normativa BS 5852-1979 Part 0 cigarettes test.

**TEJIDO TECH**  
Tejido hecho a mano en Italia, compuesto por: 75% algodón, 25% seda. El tejido Lux es un material sostenible y ecológico con fibras de algodón recicladas y seda biodegradables.

**TEJIDO TECH**  
Tejido producido artesanalmente en Italia, compuesto por: Poliéster 100% Trevira CS Resistencia a la abrasión, Martindale prueba de 75.000 rpm. Resistencia al pilling, clase 5. Resistencia a la decoloración, Xenotest clase 5/6. Conforme a la normativa BS 5852:2006 Source 5 CRIB 5, BS 5852:1990 secc.4 part.1 cigarettes test.

**SÍMIL CUERO**  
Material de última generación fabricado íntegramente en Italia y libre de componentes de origen animal, compuesto por: 8% poliéster, 4% poliuretano, 88% PVC, composición textil: 100% poliéster. Producto exclusivo Rimadesio, resistente y de altas prestaciones, libre de ortofalatos, en línea con el reglamento europeo Reach para la protección de la salud y el medio ambiente frente a los riesgos de las sustancias químicas.

Cada fase de producción del simil cuero Rimadesio cumple con las normativas vigentes en materia ambiental y de gestión de la calidad.

**CUERO**  
Verdadero cuero de vaca natural, obtenido por el proceso de curtido. La superficie es pintada para obtener los diferentes colores como en el catálogo.

**POROSHKOVOE POKRYTIIE LAKOVYM ÉFFEKТОM**  
Стойкость порошкового покрытия к отслаиванию соответствует требованиям стандарту. Коррозионная стойкость анодированного покрытия соответствует требованиям стандарта. Определение твердости порошкового покрытия соответствует требованиям стандарта.

**ИСКУССТВЕННАЯ КОЖА**  
Материал последнего поколения, произведенный полностью в Италии и не содержащий компонентов животного происхождения, состоит из полиэстера 8%, полиуретана 4%, пвх 88%, тканевая основа — полиэстер 100%. Эксклюзивный продукт Rimadesio, прочный и высокоэффективный, не содержащий орто-фталатов, в соответствии с европейским регламентом Reach по защите здоровья и окружающей среды от рисков, связанных с химическими веществами. Каждый этап производства искусственной кожи Rimadesio соответствует действующим стандартам в области экологии и управления качеством.

**КОЖА**  
Настоящая телечья кожа, полученная методом дубления. Поверхность окрашивается в различные цвета согласно каталогу.

**ОТДЕЛКА СЕРЫМ НИКЕЛЕМ**  
Отделка серым никелем достигается путем нескольких этапов окрашивания с использованием современных эмалей, придающих вид наиболее естественного окисления металла. Особый глянцевоый эффект — результат ручной обработки сырья щеткой и полировки.

**ШПОН**  
Шпонированные элементы, такие как столешницы, контейнеры и полки, изготавливаются из шпона, соответствующего нормам выделения формальдегида. Окраска осуществляется при открытых порах с использованием нетоксичной прозрачной матовой акриловой грунтовки и финишного покрытия.

**ЛИТЕСН**  
Керамическая плитка, изготовленная из чистойшифы минералов, расплавленных при высокой температуре, производится с использованием инновационной технологии полностью цифровой печати с применением экологически чистых и устойчивых красок и глазурей на водной основе. Материал характеризуется постоянным антибактериальным эффектом благодаря действию отрицательных ионов серебра, интегрированных перед окончательной обработкой запеканием при температуре 1200°.

**ТАКАНЬ «МАТЕРИАЛ»**  
Полотно, произведенное вручную в Италии, состоит из вискозы 43%, хлопка 36%, полиэстера 15%, льна 6%. Устойчивость к истиранию, тест Мартиндейла 25 000 об/мин. Сопrotивление пиллингу, класс 4. Устойчивость к выцветанию, класс 5 по Ксенотесту. Соответствует стандарту BS 5852-1979 часть 0 тест на тлеющую сигарету.

**ТАКАНЬ «LUX»**  
Полотно, изготовленное вручную в Италии, состоит из хлопка 75%, шелка 25%. Полотно Lux — это экологичный и безопасный для окружающей среды материал, в состав которого входят переработанный хлопок и биоразлагаемые шелковые волокна.

**ТАКАНЬ «ТЕСН»**  
Ткань ручной работы из Италии, состоит из: 100% полиэстера Trevira CS. Устойчивость к истиранию, тест Мартиндейла 75 000 об/мин. Сопrotивление пиллингу, класс 5. Устойчивость к выцветанию, Xenotest класс 5/6 Соответствует BS 5852:2006 Source 5 CRIB 5, BS 5852:1990 sec.4 part.1 тест на тлеющую сигарету.

**ИСКУССТВЕННАЯ КОЖА**  
Материал последнего поколения, произведенный полностью в Италии и не содержащий компонентов животного происхождения, состоит из полиэстера 8%, полиуретана 4%, пвх 88%, тканевая основа — полиэстер 100%. Эксклюзивный продукт Rimadesio, прочный и высокоэффективный, не содержащий орто-фталатов, в соответствии с европейским регламентом Reach по защите здоровья и окружающей среды от рисков, связанных с химическими веществами. Каждый этап производства искусственной кожи Rimadesio соответствует действующим стандартам в области экологии и управления качеством.

**КОЖА**  
Настоящая телечья кожа, полученная методом дубления. Поверхность окрашивается в различные цвета согласно каталогу.

**ALUMINIUM**  
POLYMER FINISHING  
Detachment resistance of the layer of powder paint conforms to the norm.  
Corrosion resistance of the powder paint conforms to Machu test results and to the norm. Fingerprint resistance of the powder paint conforms to the norm.

**ALUMINIUM**  
LACQUERED FINISHING  
Detachment resistance of the layer of powder paint conforms to the norm.  
Corrosion resistance of the powder paint conforms to Machu test results and to the norm. Fingerprint resistance of the powder paint conforms to the norm.

**GLOSSY ALUMINIUM FINISHING**  
The glossy aluminium is realized through the procedure of scraping and polishing of the aluminium, both artisanal processes carried out through last generation plants.

**NICKEL GRIGIO FINISHING**  
The nickel grigio finishing is obtained through several painting layers with the latest generation of enamels, capable of creating the appearance of the most natural metal oxidations. The special glossy effect is the result of a manual brushing and polishing process carried out on the raw material.

**ANODIZED FINISHING**  
Abrasion resistance of the anodised finish conforms to the norm. Corrosion resistance of the anodised finishing conforms to the norm.

**WOOD**  
Veneered elements, such as tops, cabinets and shelves, are produced by using materials in compliance with current regulations concerning the emissions of formaldehyde. Open pore painting with primer and non-toxic matt transparent acrylic finishing.

**LITECH**  
Litech is a compact, hard, coloured and non-porous ceramic material, obtained through a mixture of clays, sand and other natural substances, that cooked at a high temperature (1000-1300 °C). The exclusive controlled intensity variation weave, created with the most innovative molding techniques with water-based ecologic and sustainable inks and enamels. High resistance to abrasion.

**MATERIAL FABRIC**  
Italian handcraft fabric made of: viscose 43%, cotton 36%, polyester 15%, linen 6%. Resistance to scraping, Martindale test 25,000 twists. Resistance to pilling, class 4. Resistance to discolouration, Xenotest class 5. Conforms to BS 5852-1979 part 0 cigarettes test.

**LUX FABRIC**  
Italian handcraft fabric made of: cotton 75%, silk 25%. Lux fabric is a sustainable and environmentally friendly material with recycled cotton fibers and biodegradable silk.







**TECH FABRIC**  
Italian handcraft fabric made of: polyester 100% Trevira CS. Resistance to scraping, Martindale test 75,000 twists. Resistance to pilling, class 5. Resistance to discolouration, Xenotest class 5/6 Conforms to BS 5852:2006 Source 5 CRIB 5, BS 5852:1990 sez.4 part.1 cigarette test.

**SYNTHETIC LEATHER**  
Latest generation material entirely produced in Italy and animal-derived components free, made of: polyester 8%, polyurethane 4%, pvc 88%, textile composition: polyester 100%. It is an exclusive by Rimadesio, resistant and high performing, it is also ortho- phthalates free, in accordance with the European Reach regulation for the protection of human health and the environment from the risks of chemical substances. The production system of Rimadesio synthetic leather complies with current environmental and quality standards.





ECOLORSYSTEM MATT LACQUERED

 305 cipria	 45 avorio	 59 grigio chiaro	 40 grigio cenere	 53 bianco neve	 16 bianco latte
 51 nocciola	 52 corda	 56 lino	 312 grigio seta	 47 grigio perla	 78 sabbia
 306 terracotta	 85 tufo	 310 creta	 38 azzurro cera	 36 blu Londra	 74 canapa
 76 rosso india	 308 pepe	 317 grigio artico	 35 blu notte	 39 verde inglese	 73 giallo kashmir
 75 amaranto	 309 sandalo	 88 grigio scuro	 86 blu oceano	 314 verde lichene	 43 laguna
 307 java	 58 caffè	 311 grigio lava	 313 blu scuro	 315 verde scuro	 33 verde oliva
	 84 moro	 13 nero			 316 verde terra

ECOLORSYSTEM LACQUERED METALIZED

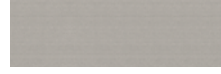
 304 platino	 302 grafite
 69 palladio	 303 bronzo
 83 piombo	 300 rame
 301 petro	

ALUMINIUM

 31 alluminio lucido
 30 alluminio
 14 brown
 318 nickel grigio
 22 nero lucido

LEATHER

 C23 bianco ghiaccio
 C17 sand
 C29 toupè
 C22 caramello
 C28 fango
 C11 moka

SYNTHETIC LEATHER

 157 arena
 158 agata
 155 nube
 154 argilla
 160 miele
 153 castoro
 159 etna
 156 rubens











LUX FABRIC

 T006 gesso
 T052 segale
 T044 acciaio
 T012 marmotta
 T042 ruggine
 T051 salvia

MATERIAL FABRIC

 T020 nebbia
 T019 papiro
 T009 piuma
 T017 roccia
 T001 terracotta
 T003 brandy
 T018 tabacco









TECH FABRIC

 TT01 duna
 TT03 tortora
 TT05 mosto
 TT07 antracite
 TT09 fumo
 TT10 ghiaccio
 TT11 giada
 TT19 canyon
 TT20 dolomiti
 TT21 cedro

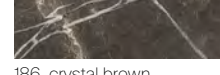
RAFIA

 T133 magnolia
 T134 desert
 T101 natural
 T115 stone
 T102 sequoia

MARBLE

 28 calacatta
 188 sierra beige
 184 crystal grey
 186 crystal brown
 180 emperador
 183 noir saint laurent
 187 verde lepanto
 182 rosso lepanto
 181 nero marquinia

MATT MARBLE

 198 calacatta opaco
 194 crystal grey opaco
 191 nero marquinia opaco
 185 crystal white opaco

LITECH

 G001 crema
 G002 moka
 G003 piedra
 G004 grigio rigato

WOOD

 711 rovere
 15 noce
 19 rovere termotrattato
 27 rovere nero
 710 tinto ebano

TAIGA WOOD

 701 rovere taiga
 700 tinto ebano taiga



SAHARA WOOD

 17 noce sahara
 20 rovere termotrattato sahara

MELAMINE

 07 melaminico olmo
 09 melaminico rovere grigio
 25 melaminico larice carbone

INTERNAL MELAMINE

 UB07 mel. cuoio grigio
 UB09 mel. cuoio brown

Collection designed by Giuseppe Bavuso.

Art direction and graphic project: Juma  
Photo: Federico Cedrone, Santi Caleca  
Technical photo: F2 Fotografia  
Styling: Studiopepe; Patrizia Cantarella with Rossella Ballabio;  
Martina Lucatelli with Martina Dalla Bona;  
Simona Silenzi Studio; Gaia Marchesini and Giordano Sarno.

Thanks to: Afolki, Agape, Ames, Amini Carpets, aponteboretti, Arnolfo di Cambio, Artemide, Astep, AYTM, Azucena, B&B Italia, Baxter, Bitossi Ceramiche, Brionvega, Carl Hansen & Søn, Claire Lune, Cooeee Design, Danese Milano, Dany GILLES, Davide Groppi, De Vecchi Milano 1935, Dechem Studio, Dep Art Gallery, Egidio Milesi, Emil, Etel Milano, Flexform, Flos, FontanaArte, FPM Milano, Fritz Hansen, Gan Rugs, Gardeco, Gervasoni 1882, Henry Timi, Ittala, Ivano Redaelli, Iwata Mokku, J. & L. Lobmeyr, Knoll, Lanerossi, Lindell & Co, Living Divani, Lorenzo Franceschinis, Louis Poulsen, Maru Gallery, Matteo Thun Atelier, distributed by Manus Factor, Maxalto, Nemo Lighting, Noorstad, Noorth, Nude Glass, NUMA Limited Editions, Nuove Forme, Officine Saffi, Oluce, Pallucco, Phantom Hands, Raawi, Rains, Raumgestalt, Riva 1920, Scandola marmi, Serafino Zani, Skagerak, Society, STELTON distribuito da Schönhuber Spa, Suede, Tacchini, Terry Davies Ceramics, Unurgent Argilla, Up To You Anthology, Vitra, When Objects Work.

Films and print: Optima  
Update, May 2024

RIMADESIO SPA  
Via Furlanelli 96  
20833 Giuszano (MB) Italy  
T +39 0362 3171  
rimadesio@rimadesio.it

MILANO FLAGSHIP STORE  
Via Visconti di Modrone 26  
20122 Milano Italy  
T +39 02 76280708  
milano@rimadesio.it

LONDON FLAGSHIP STORE  
83-85, Wigmore street  
1WU 1DL London  
T +44 2074 862193  
london@rimadesio.co.uk

NEW YORK FLAGSHIP STORE  
102 Madison Ave  
New York, NY 10016  
T +1 917 388 2650  
usa@rimadesio.us

PARIS FLAGSHIP STORE  
25, Avenue Rapp  
75007 Paris  
T +33 171930682  
paris@rimadesio.fr

www.rimadesio.it

#### AWARDS

1993	Siparium	Young & Design
2000	Zenit	Award KBB
2001	Zenit	selection Design Index ADI
2002	Siparium	Top100 Frames
2005	Graphis	selection Design Index ADI
2007	Vela	selection Design Index ADI
2008	Vela	mention XXI Premio Compasso d'Oro ADI
2015	Wind	winner Red Dot Award
2016	Cover	Best Furniture System AZ Award
2016	Alambra	selection Design Index ADI
2017	Sail	selection Design Index ADI
2017	Soho	Architectural products AZ awards
2017	Daimon	Interior Design Magazine Best of Year awards
2020	Modulor	People's Choice winner AZ Awards
2020	Modulor	Architectural Products Award of Merit AZ Awards
2020	Modulor	selection Design Index ADI
2021	Francis	selection Design Index ADI
2021	Modulor	LivingEtc Style Awards
2022	Maxi	selection Design Index ADI
2022	Aliante	finalist Interior's best of the Year awards
2022	Aliante	finalist A+Product awards
2023	Maxi	winner German Design Awards
2023	Radius	Architect's Newspaper's Best of Products Awards

#### PATENTED:

Air, Radius, Aliante, Rialto, Maxi, Sail, Soho, Velaria, Stripe, Daimon, Graphis, Zen, Zen frame, Siparium, Moon, Vela, Luxor, Even, Aura, Spin, Link+, Planet, Flat, Alambra, Abacus living, Self, Cover, Zenit, Dress bold, Abacus.

#### REGISTERED TRADEMARKS:

Rimadesio, Colorsystem, Litech, Siparium, Velaria, Abacus.



Follow us on Instagram, Facebook, LinkedIn,  
WeChat, Weibo, Little Red Book.

