

ZENIT

Rimadesio



THE WALK-IN CLOSET THAT'S ALL ABOUT LIGHTNESS AND VERSATILITY OF COMPOSITION. THE MADE-TO-MEASURE FLOOR-TO-CEILING UPRIGHTS ENABLE FREE ARRANGEMENT OF THE EQUIPMENT, BOTH IN TERMS OF NUMBER AND HEIGHT REQUIRED. THE AVAILABLE FINISHINGS INVITE TWO POSSIBLE AESTHETIC INTERPRETATIONS.

IT La cabina armadio all'insegna della leggerezza e della versatilità compositiva. I montanti, sempre su misura da terra a soffitto, permettono una libera disposizione delle attrezzature, nel numero e all'altezza desiderata. Le finiture previste invitano a due possibili interpretazioni estetiche.

DE Der begehbare Kleiderschrank im Zeichen von Leichtigkeit und Gestaltungsvielfalt. Die raumhohen Stützen nach Maß erlauben eine freie Anordnung der Ausstattung, in der gewünschten Anzahl und in der gewünschten Höhe. Die angebotenen Oberflächen regen zu zwei unterschiedlichen ästhetischen Interpretationen an.

FR Le dressing sous le signe de la légèreté et d'une composition polyvalente. Les montants sont toujours réalisés sur mesure du sol au plafond et permettent une disposition libre des équipements, en nombre et à la hauteur souhaitée. Les finitions prévues invitent à deux interprétations esthétiques possibles.

ES El vestidor ofrece ligereza y versatilidad compositiva. Los montantes, siempre hechos a medida desde el suelo hasta el techo, permiten disponer libremente todos los accesorios, usando el número necesario a la altura deseada. Los acabados disponibles invitan a dos posibles interpretaciones estéticas.

RU Гардеробная, характеризующаяся легкостью и композиционной универсальностью. Стойки от пола до потолка позволяют свободно размещать оснащение в нужном количестве и на нужной высоте. Предусмотренные варианты отделки предполагают две возможные эстетические интерпретации.

汉语 步入式衣橱的核心在于轻盈感和组合多样性。立柱皆由地面至天花板按尺寸定制，可根据所需的配件数量和高度自由配置。多样的表面处理可演绎出两种设计美学。

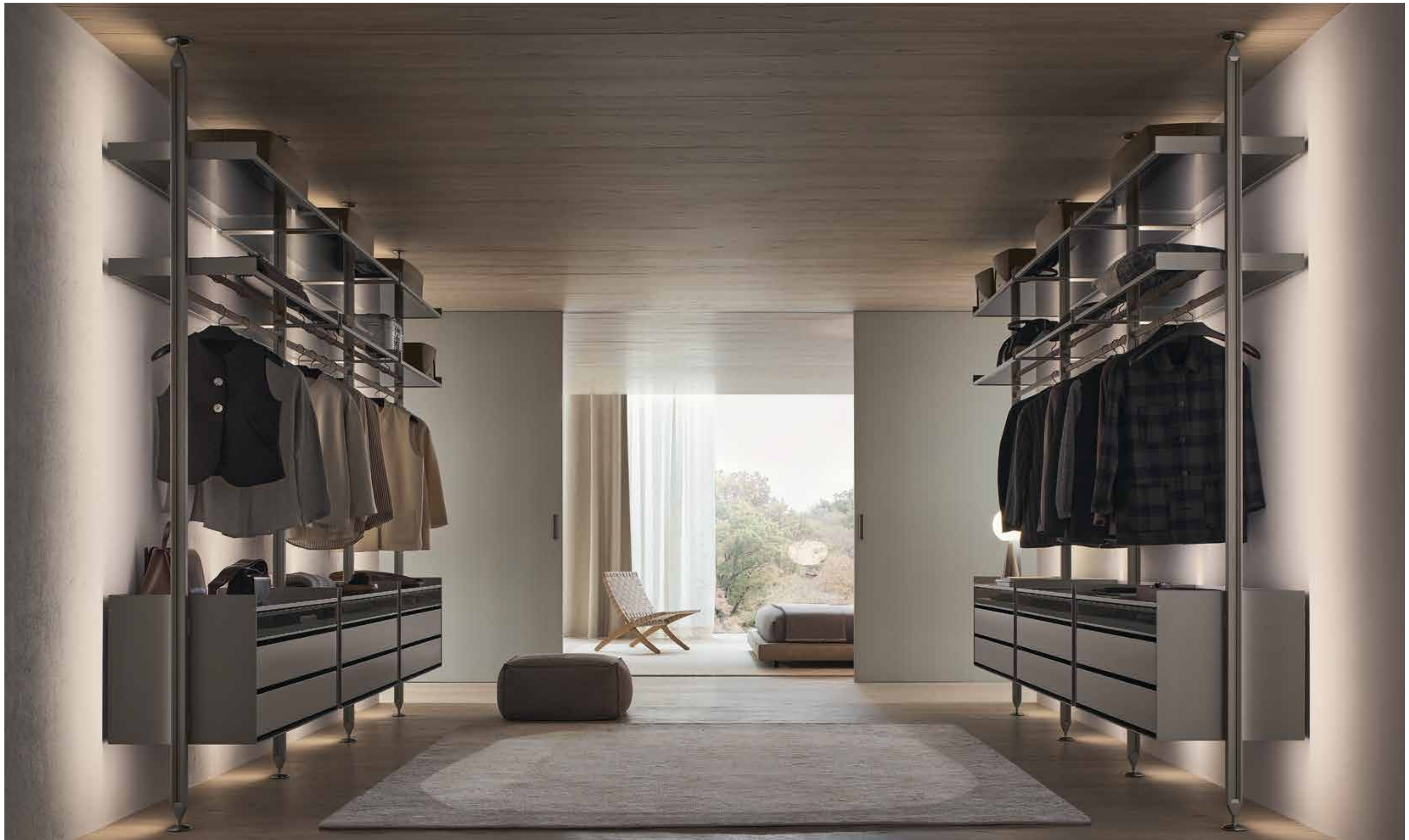

WALK-IN CLOSETS / ZENIT

Structure and aluminium fronts: 304 platino
Drawer unit top and glass front: 67 riflettente chiaro
Lux fabric internal lining: T052 segale
Glass shelves: 63 grigio trasparente

In this photo
Sliding doors: Graphis plus

EN The Zenit walk-in closet expands its design potential with the introduction of an exclusive range of modular drawer units, made with the latest production technologies for processing extruded and sheet aluminium. The aluminium drawers are just 8 mm thick and internally lined with fabric or synthetic leather. Available in three widths, three heights and four aesthetic formats to meet highly personal demands concerning the organisation of walk-in closets: open drawers without fronts, drawers with glass fronts, drawers with lacquered fronts and drawers with synthetic leather fronts.

IT La cabina armadio Zenit amplia le proprie potenzialità progettuali con l'introduzione di un esclusivo programma di cassettiere modulari e componibili, realizzate con le più recenti tecnologie produttive per la lavorazione dell'alluminio estruso e in lastra. I cassetti in alluminio, dallo spessore di soli 8 mm, sono rivestiti internamente in tessuto o similpelle. Disponibili in tre larghezze, tre altezze e in quattro versioni estetiche, rispondono alle esigenze più personali nell'organizzazione della cabina armadio: cassetto aperto senza frontale, cassetto con frontale in vetro, cassetto con frontale in alluminio laccato e cassetto con frontale in similpelle.

DE Der begehbare Kleiderschrank Zenit erweitert seine Gestaltungsmöglichkeiten mit der Einführung eines exklusiven Programms von modularen und kombinierbaren Schubladenelementen, die mit den neuesten Produktionstechnologien zur Verarbeitung von stranggepresstem Aluminium und Aluminiumblech hergestellt werden. Die Schubladen aus Aluminium, mit einer Stärke von nur 8 mm, sind innen mit Stoff oder Kunstleder ausgekleidet. Die in drei Breiten, drei Höhen und vier ästhetischen Versionen erhältlichen Schubladen erfüllen sämtliche individuellen Anforderungen an die Organisation des begehbaren Kleiderschranks: offene Schublade ohne Frontblende, Schublade mit Glasfrontblende, Schublade mit lackierter Aluminiumfrontblende und Schublade mit Kunstlederfrontblende.

FR Le dressing Zenit élargit son potentiel de conception avec l'introduction d'un programme exclusif de commodes modulaires et modulables, réalisées avec les dernières technologies de production pour l'usinage de l'aluminium extrudé et en feuilles. Les tiroirs en aluminium, d'une épaisseur de 8 mm seulement, sont revêtus intérieurement de tissu ou de similicuir. Disponibles en trois largeurs, trois hauteurs et quatre versions esthétiques, ils répondent aux exigences de chacun pour l'organisation du dressing: tiroir ouvert sans façade, tiroir avec façade en verre, tiroir avec façade en aluminium laqué et tiroir avec façade en similicuir.

ES El vestidor Zenit amplía su potencial de diseño con la introducción de un programa exclusivo de cajoneras modulares y componibles, fabricados con las últimas tecnologías de producción del aluminio extruido y en placas. Los cajones de aluminio, de solo 8 mm de espesor, incorporan un revestimiento interior de tela o polipiel. Disponibles en tres anchuras, tres alturas y cuatro versiones estéticas que responden a las necesidades más personales relativas a la organización del vestidor: cajón abierto sin frontal, cajón con frontal de cristal, cajón con frontal de aluminio lacado y cajón con frontal de polipiel.

RU Потенциал гардеробной Zenit расширяется благодаря внедрению эксклюзивной линейки модульных и секционных комодов, изготовленных по новейшим технологиям обработки экструдированного и листового алюминия. Алюминиевые ящики толщиной всего 8 мм внутри обиты тканью или синтетической кожей. Они представлены в трех вариантах ширины, трех вариантах высоты и четырех вариантах отделки, что позволяет удовлетворить самые взыскательные требования к организации гардеробной: открытые ящики без фасада, ящики со стеклянным фасадом, ящики с фасадом из лакированного алюминия и ящики с фасадом из синтетической кожи.

汉语 通过引进一项独家的组合式模块抽屉柜方案，搭配挤压铝材和铝板工艺的最新生产技术，Zenit 步入式衣橱得以拓展设计潜力。抽屉以铝合金打造，厚度仅 8 毫米，以布面或仿真皮革包覆。这款步入式衣柜针对空间组织性的个人化需求在尺寸方面给出三种宽度和三种高度，并提供四种美学风格的抽屉版本：无抽面、带有玻璃抽面、烤漆抽面或以仿真皮革包覆的抽面。

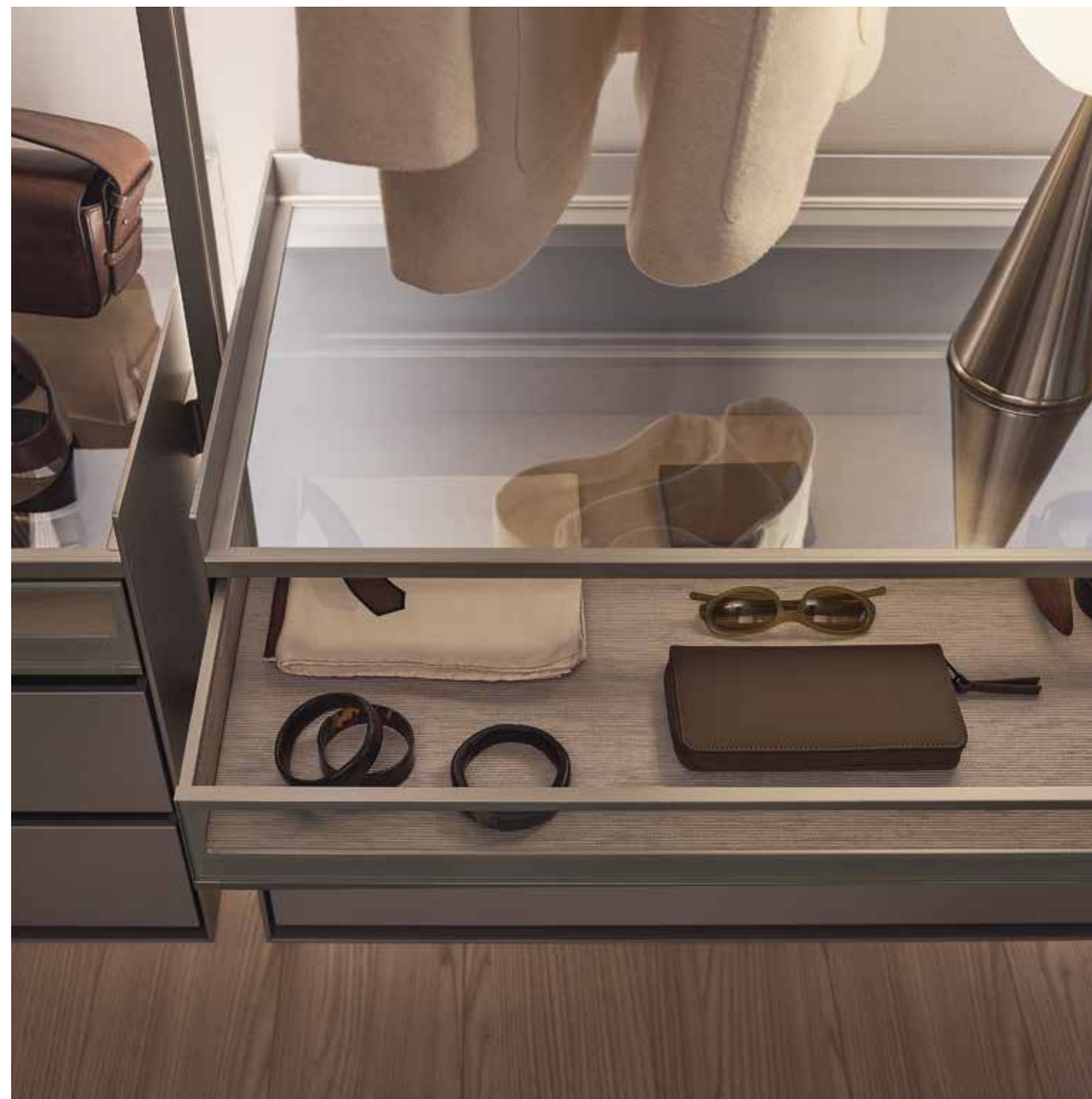

Structure and aluminium fronts: 304 platino
Drawer unit top and glass front: 67 riflettente chiaro
Lux fabric internal lining: T052 segale
Glass shelves: 63 grigio trasparente



WALK-IN CLOSETS / ZENIT

Structure: 304 platino
Glass shelves: 63 grigio trasparente
Shelves, drawer unit top, front and drawer internal lining
in synthetic leather: 154 argilla



WALK-IN CLOSETS / ZENIT

Structure: 304 platino
Shelves, drawer unit top, front and internal lining
in synthetic leather: 154 argilla

EN The Zenit modular shelves, bars and drawers can be covered in synthetic leather available in 8 exclusive Rimadesio colours. The organisation of the space is resolved with a series of components and solutions that combine essential design, maximum practicality and attention to detail.

IT I ripiani, le aste e le cassettiere modulari di Zenit possono essere rivestiti in similpelle, disponibile in 8 colori esclusivi Rimadesio. L'organizzazione dello spazio è risolta con una serie di componenti e soluzioni che associano essenzialità del design, massima praticità e ricercatezza.

DE Die Einlegeböden, Stäbe und modularen Kommoden von Zenit können mit Kunstleder bezogen werden, das in 8 exklusiven Rimadesio-Farben erhältlich ist. Die Organisation des Raums wird mit einer Reihe von Komponenten und Lösungen umgesetzt, die essenzielles Design, maximale Zweckmäßigkeit und Raffinesse vereinen.

FR Les étagères, tringles et commodes modulaires de Zenit peuvent être recouvertes de similicuir, 8 coloris exclusifs Rimadesio sont disponibles. L'espace s'organise avec une série d'éléments et de solutions qui allient design essentiel, praticité maximale et raffinement.

ES Los estantes, barras y cajoneras modulares de Zenit se pueden revestir en polipiel, disponible en ocho colores exclusivos de Rimadesio. La organización del espacio se resuelve con una serie de componentes y soluciones que combinan diseño esencial, máxima practicidad y refinamiento.

RU Полки, штанги и модульные комоды Zenit могут быть обиты синтетической кожей, представленной в 8 уникальных цветах Rimadesio. Организация пространства осуществляется с помощью ряда компонентов и решений, сочетающих в себе лаконичный дизайн, максимальную практичность и изысканность.

汉语 Zenit 的模块化层板、导轨和抽屉柜皆以 8 种 Rimadesio 的独家仿真皮革包覆。有赖于一系列涉及设计本质、最大实用性和精致品味的组合件和解决方案，空间组织性得以实现。





WALK-IN CLOSETS / ZENIT

Structure: 14 brown
Shelves and drawer units: 25 melaminico larice carbone
Accessories in synthetic leather: 153 castoro



WALK-IN CLOSETS / ZENIT

Structure: 303 bronzo
Glass shelves: 61 rete inox
Shelves, accessories and clothes-hanger bar
in synthetic leather: 154 argilla

In this photo
Storage system: Cover

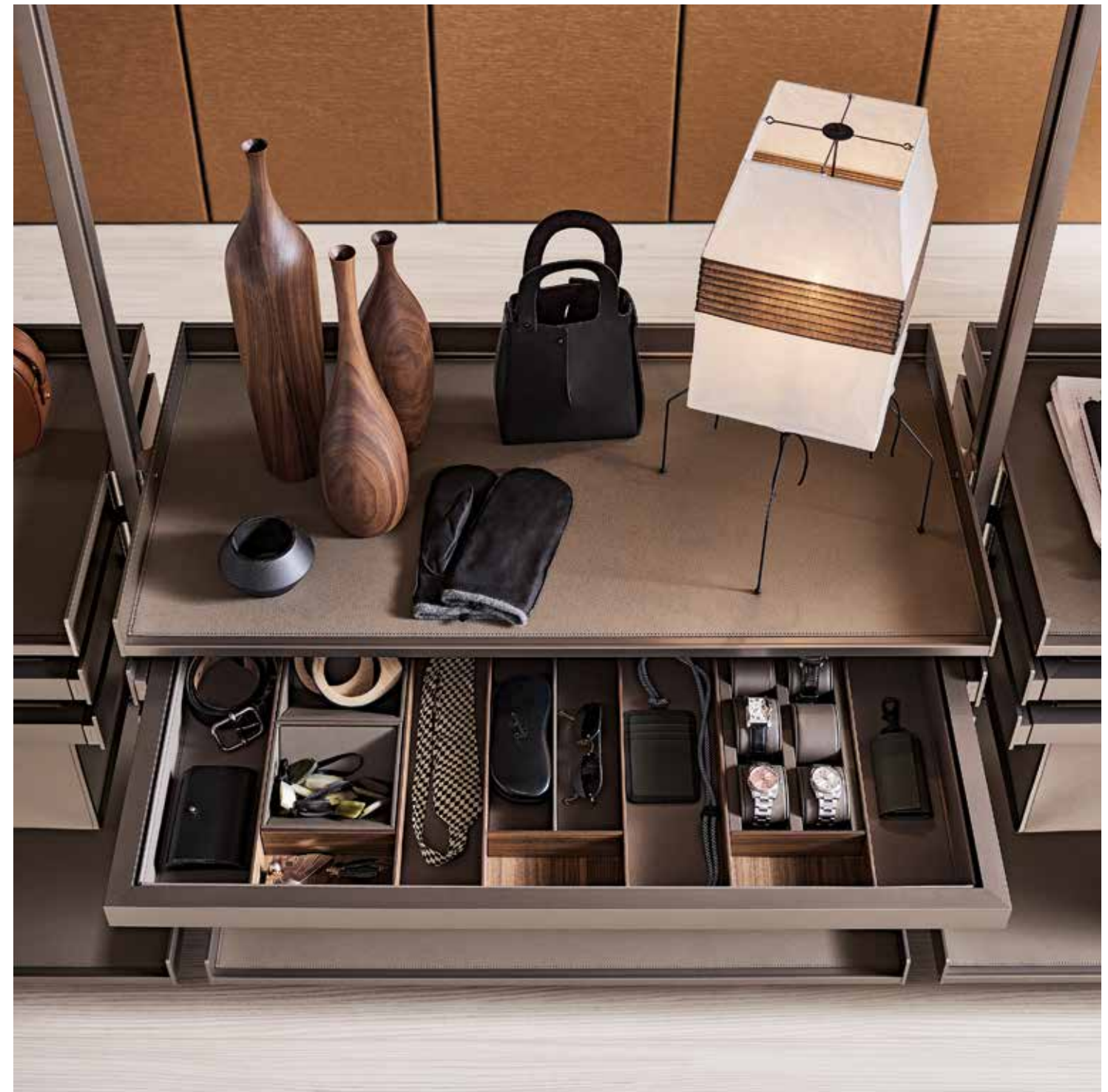

WALK-IN CLOSETS / ZENIT

Structure: 303 bronzo
Shelves and accessories in synthetic leather: 154 argilla

In this photo
Storage system: Cover

EN The aluminium upright and the exclusive fixing system guarantee maximum structural solidity to the Zenit compositions. The bracket with expansion fixing enables each individual element to be leveled. The uprights can be fitted to the ceiling and on the wall to allow the system to be used in any space.

IT Il montante in alluminio e l'esclusivo sistema di aggancio garantiscono la massima solidità strutturale alle composizioni Zenit. Il supporto con fissaggio ad espansione consente di posizionare in bolla ogni singolo elemento. I montanti sono disponibili a soffitto e a parete per consentire la collocazione del sistema in ogni ambiente.

DE Der Aluminiumständer und das einzigartige Kupplungssystem garantieren eine maximale strukturelle Stabilität der Zenit-Kompositionen. Die Halterung mit Spreizfixierung ermöglicht es, jedes Element waagrecht zu positionieren. Die Ständer sind sowohl für Decken- als auch für Wandmontage erhältlich, damit das System in jeder Umgebung aufgestellt werden kann.

FR Le montant en aluminium et le système exclusif d'accrochage garantissent une solidité structurelle maximale aux compositions Zenit. Le support avec fixation à expansion permet un positionnement parfaitement horizontal de chaque élément. Les montants au plafond et au mur permettent l'installation du système dans n'importe quel environnement.

ES El montante de aluminio y el exclusivo sistema de acoplamiento garantizan la máxima solidez estructural en las composiciones Zenit. El soporte con fijación de expansión permite colocar cada elemento a nivel. Los montantes están disponibles para montaje en el techo y en la pared, de manera que el sistema se puede utilizar en cualquier ambiente.

RU Алюминиевые стойки и уникальная система креплений гарантируют максимальную прочность конструкции композиций Zenit. Кронштейн с бесшаговым креплением позволяет максимально ровно выставить каждый элемент по горизонтали. Монтаж стоек можно осуществлять к стенам или к потолку, благодаря чему систему можно установить в любом помещении.

汉语 铝制立柱和独特的连接系统确保Zenit组合具有最大的结构稳固性。带有膨胀固定装置的支架使每个单独元件能够平稳安装。该系统的立柱有天花板式和墙面式可供选择，两者在任何环境中皆可安装。





WALK-IN CLOSETS / ZENIT

Structure: 303 bronzo
Shelves and drawer units: 07 melaminico olmo
Accessories in synthetic leather: 153 castoro

EN Rimadesio has always paid particular attention to the search for new colours and material surfaces. This attitude is also reflected in solutions that are always coordinated on the inside and outside of the cabinets, including the finishings of the metal and synthetic leather components, the wood and the lacquering of glass.

IT Rimadesio presta da sempre un'attenzione particolare alla ricerca di nuove cromie e superfici materiche. Quest'attitudine si riflette anche nella garanzia di soluzioni sempre coordinate tra interno ed esterno dei contenitori, tra le finiture dei componenti metallici e in similpelle, le essenze e le laccature dei vetri.

DE Rimadesio legt seit jeher ein besonderes Augenmerk auf die Suche nach neuen Farben und Materialoberflächen. Dieses Bestreben spiegelt sich auch in der Bereitstellung von Lösungen wider, die stets zwischen dem Inneren und dem Äußeren der Behälter, zwischen den Oberflächen der Metall- und Kunstlederkomponenten, den Hölzern und der Lackierung des Glases abgestimmt sind.

FR Rimadesio a toujours accordé une attention particulière à la recherche de nouvelles couleurs et de nouveaux matériaux de finition. Cette attitude transparait également dans la garantie de solutions toujours coordonnées entre l'intérieur et l'extérieur des rangements, entre les finitions des éléments en métal et en similicuir, les essences et les laquages des surfaces en verre.

ES Rimadesio siempre ha prestado especial atención a la búsqueda de nuevos colores y superficies materiales. Esta actitud también se refleja en la garantía de soluciones siempre coordinadas entre el interior y el exterior de los contenedores, entre los acabados de los componentes metálicos y de polipiel, las maderas y el lacado del vidrio.

RU Компания Rimadesio всегда уделяла особое внимание поиску новых оттенков и материалов поверхностей. Это отношение также отражается в предоставлении решений, согласующихся с внутренним и внешним видом систем хранения, и сочетающихся отделкой металла и синтетической кожи, дерева и лакировкой стекла.

汉语 Rimadesio 在找寻新色彩和表面材质方面的研究始终不遗余力。这份底蕴也体现在确保柜体内部和外部协调的解决方案上的坚持不懈,包括金属和人造皮革部件的饰面、各种不同类型的木材和玻璃烤漆。



EN An architectural value for the walk-in closet: with the monochrome black offer, the Zenit system becomes a stylistic element of great room characterization. The elements of the system can be freely positioned, in the number and at the height required.

IT Un valore architettonico per la cabina armadio: con la proposta monocolore nero, il sistema Zenit diventa un elemento stilistico di grande caratterizzazione degli ambienti. Gli elementi del sistema sono liberamente posizionabili, nel numero desiderato e all'altezza desiderata.

DE Ein begehrter Kleiderschrank von architektonischem Wert: Mit der einfarbig schwarzen Ausführung wird das Zenit-System zu einem Stilelement von großer Raumwirkung. Die Systemelemente sind sowohl in der gewünschten Anzahl als auch in der gewünschten Höhe frei positionierbar.

FR Une valeur architecturale pour le dressing: avec le modèle noir, le système Zenit devient un élément stylistique qui donne beaucoup de caractère aux pièces. Les éléments du système peuvent être positionnés librement, en nombre et à la hauteur souhaitée.

ES Un valor arquitectónico para el vestidor: con la propuesta monocolor en negro, el sistema Zenit se convierte en un elemento estilístico que aporta un gran carácter a los ambientes. Los elementos del sistema se pueden colocar libremente, usando el número necesario a la altura deseada.

RU Архитектурная ценность гардеробной: монохромный черный цвет системы Zenit – стилистическое решение, придающее помещению особый характер. Элементы системы размещаются в нужном количестве и на нужной высоте.

汉语 步入式衣柜的建筑价值: Zenit 系统采用单一黑色, 其转化为极具特色的空间风格元素, Zenit系统的各式布件可以根据需求的数量和高度自由配置。





WALK-IN CLOSETS / ZENIT

Structure: 83 piombo
Glass shelves: 63 grigio trasparente
Accessories in synthetic leather: 154 argilla
Drawer units: 09 melaminico rovere grigio



WALK-IN CLOSETS / ZENIT

Structure: 14 brown
Shelves: 25 melaminico larice carbone
Shelves, accessories and clothes-hanger bar
in synthetic leather: 153 castoro

In this photo
Sliding doors: Velaria

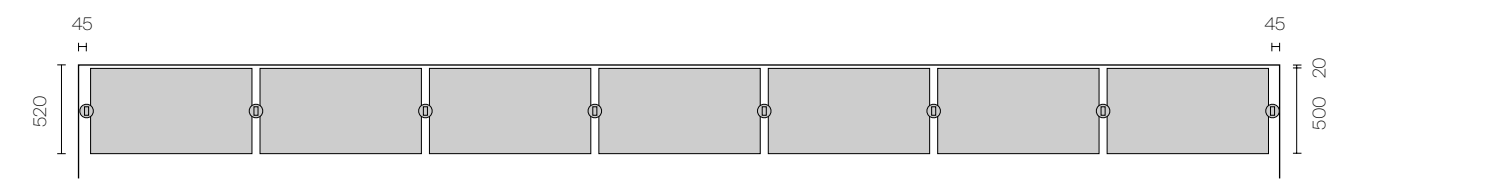
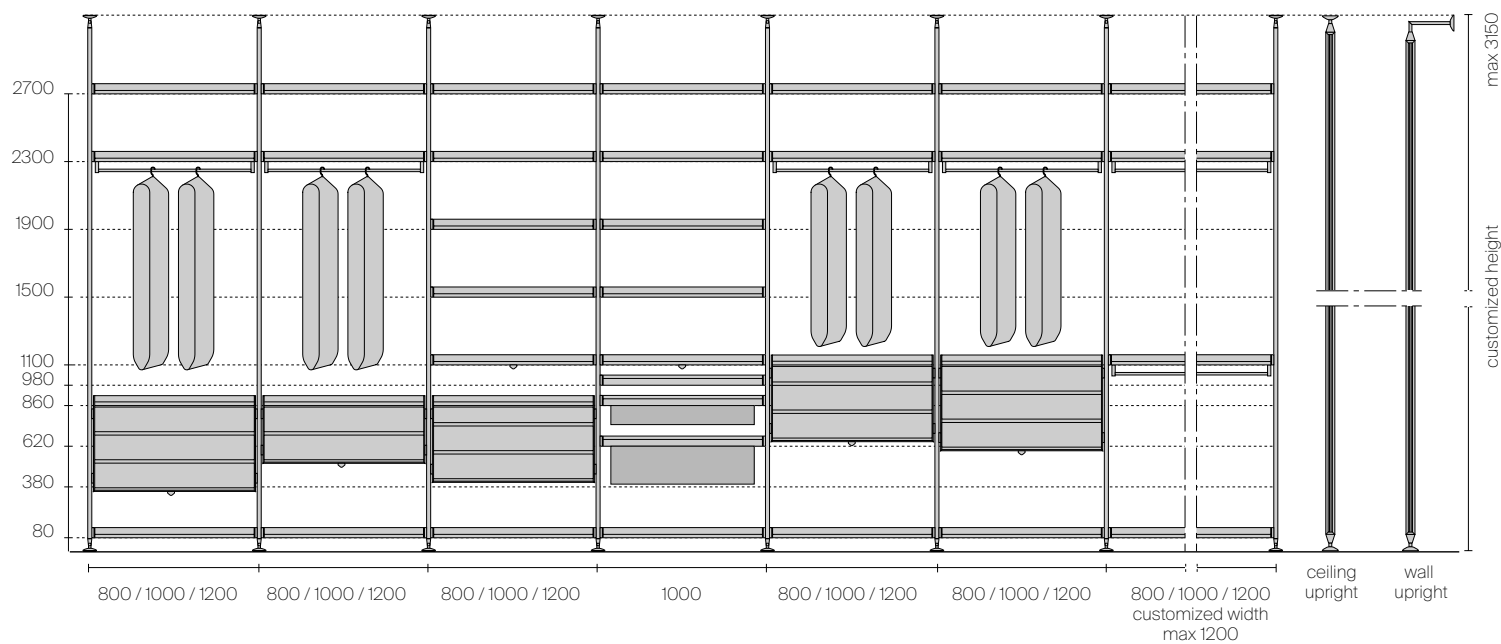
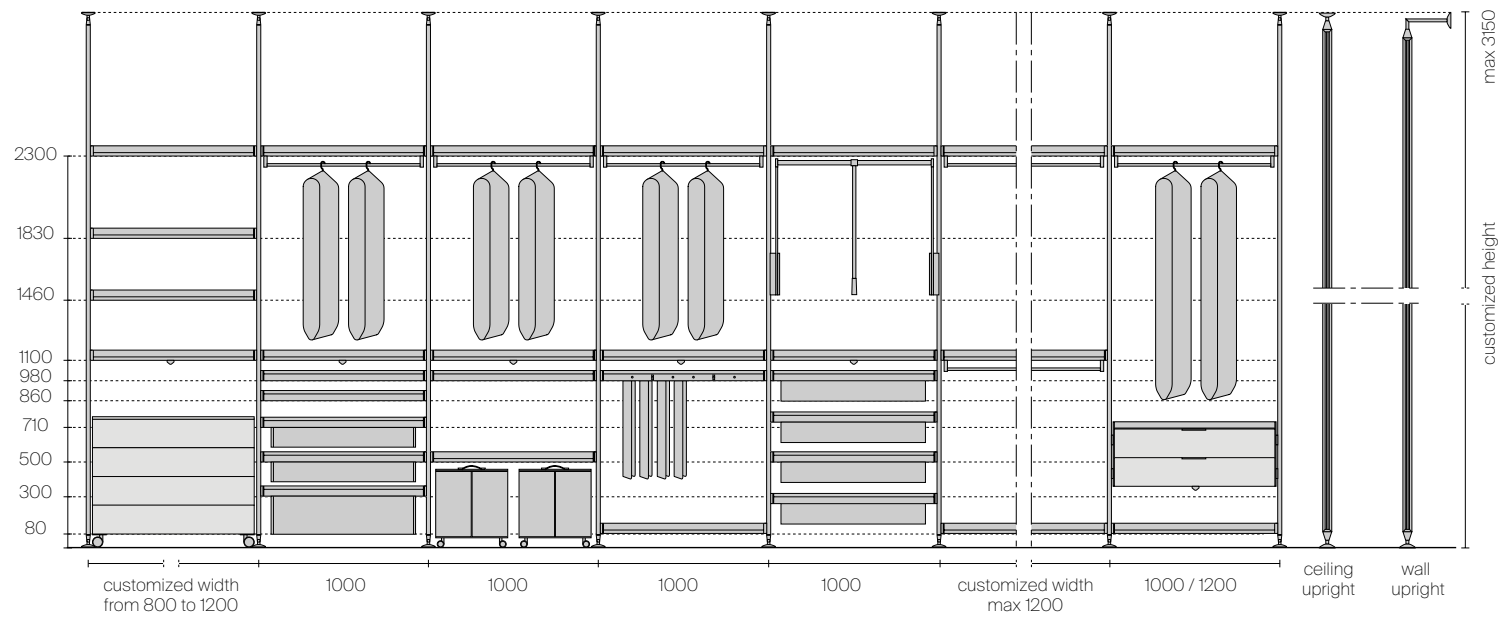

TECHNICAL DESCRIPTION

EN Zenit compositions are always custom-made in height, with wall or ceiling uprights. Shelves and cloth hanger bars are available with three widths, with the possibility to reduce them. All the other elements are available only with the indicated width.

IT Le composizioni Zenit vengono sempre realizzate su misura in altezza, con possibilità di montanti a parete o a soffitto. Le mensole e le barre portabiti sono disponibili in tre larghezze, con inoltre la possibilità di riduzione a misura. Tutti gli altri componenti sono disponibili solo nella larghezza indicata.

DE Zenit Anlage sind immer nach Mass in Hoehe, mit Wand oder Decke-Pfosten hergestellt. Fachboeden und Kleiderstange sind mit drei Breiten verfuegbar. Es is auch moeglich sie nach Mass zu kuerzen. Die andere Zube hoeren sind nur mit der angegebenen Breite verfuegbar.

FR Les compositions Zenit sont toujours sur mesure en hauteur, avec les montants à fixation murale ou au plafond. Les étagères et les tiges porte-manteaux sont disponibles en trois largeurs avec la possibilité de les réduire sur mesure. Tous les autres accessoires sont disponibles seulement dans la dimension indiquée.

ES Las composiciones Zenit están siempre realizadas a medida en altura, con posibilidad de montantes a pared o a techo. Los estantes y las barras de colgar están disponibles en tres anchuras, con la posibilidad de reducción a medida. Los otros accesorios están disponibles sólo en la anchura indicada.

RU Композиции Zenit всегда изготавливаются по индивидуальному размеру по высоте, с возможностью настенного или потолочного монтажа стоек. Полки и штанги для одежды представлены в трех вариантах ширины с возможностью уменьшения до нужного размера. Все остальные компоненты доступны только в указанной ширине.

汉语 Zenit 组合件的高度皆按尺寸定制，立柱可安装于墙面或天花板。层板和衣杆有三种长度可供选择，并可根据需要缩短尺寸。其他所有的部件皆只提供指定宽度。

Linear composition

Calculation of the length of the shelf A
shelf W = minimum opening W - 1000 - 1000 - 90 mm

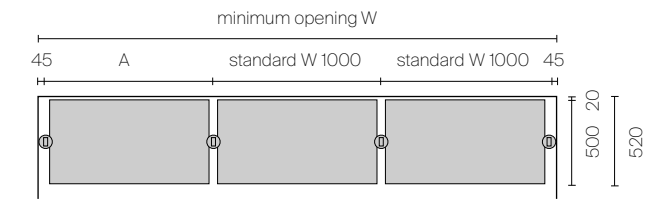

Corner composition with linear shelves

Calculation of the length of the shelf A
shelf W = minimum opening W - 580 - 1000 mm
Calculation of the length of the shelf B
shelf W = minimum opening W - 1000 - 90 mm

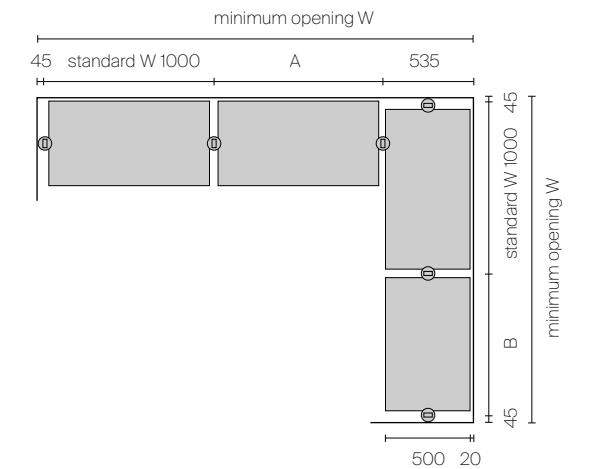

C-shaped composition with linear and corner shelves

Calculation of the length of the shelf A
shelf W = minimum opening W - 65 - 1165 mm
Calculation of the length of the shelf B
shelf W = minimum opening W - 40 - 1165 - 1165 mm

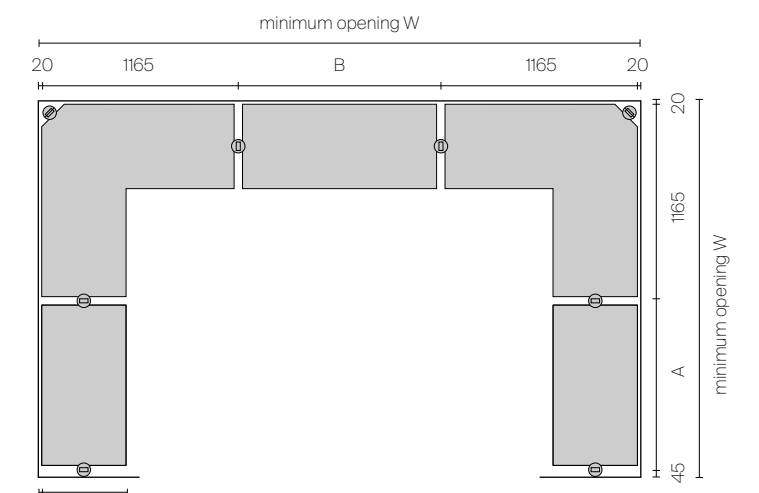

UPRIGHTS



1. Ceiling upright
2. Wall upright
3. Shelf with perimetrical ring in extruded aluminium
4. Bayonet fixing between the shelf and the die casting support
5. Structural upright in extruded aluminium
6. Support with expansion fixing system which allows to adjust the position of the accessories



1

2

3

4

5

6

PULL-OUT ACCESSORIES IN SYNTHETIC LEATHER



1. Pull-out shelf with tie rack
2. Pull-out shelf with organizer tray
3. Pull-out shelf with shoe rack
4. Pull-out shelf with trousers rack and belts tray



1

2

3

4

Ceiling

Ceiling backlighted

Wall

Wall backlighted

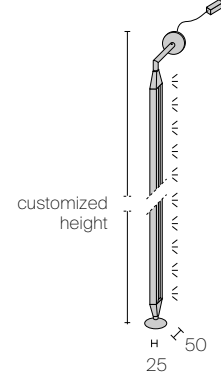
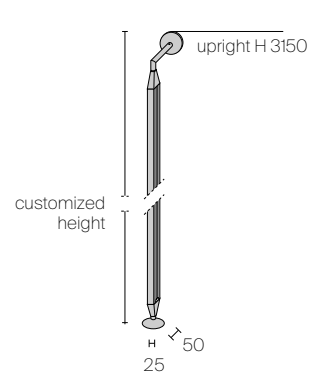
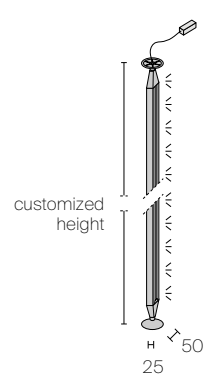
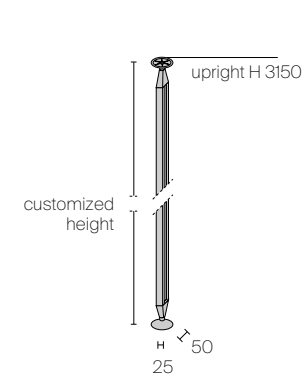

Pull-out small tray in synthetic leather

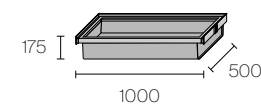

Pull-out big tray in synthetic leather

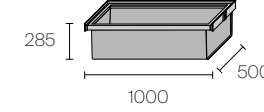

Pull-out shelf with organizer tray in synthetic leather

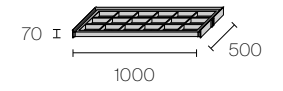

Pull-out shelf with trousers rack and belts tray in synthetic leather

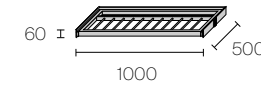

Pull-out shelf with tray rack in synthetic leather

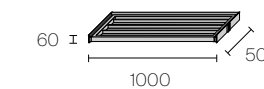

Pull-out shelf with shoe rack in synthetic leather

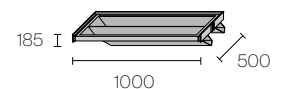



1



2



3



4



5



6



7

1. Suspended drawer unit with 2 aluminium fronts
2. Suspended drawer unit with 1 glass front and 1 aluminium front
3. Suspended drawer unit with 2 synthetic leather fronts
4. Suspended drawer unit with 1 glass front and 1 synthetic leather front
5. Suspended drawer unit with 2 open fronts
6. Suspended drawer unit with 1 glass front and 1 open front
7. Suspended drawer unit with 2 glass fronts

H 400 with two drawers

2 aluminium fronts

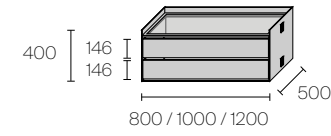

2 glass fronts

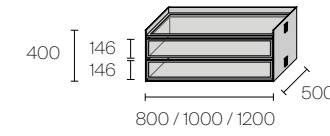

2 synthetic leather fronts

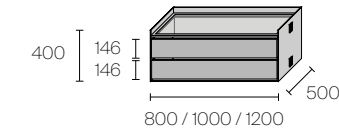

2 open fronts

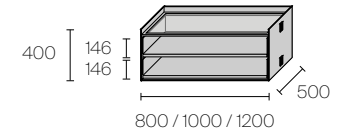

1 glass front, 1 open front

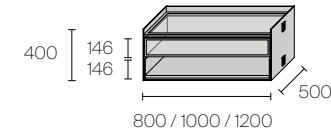

1 glass front, 1 aluminium front

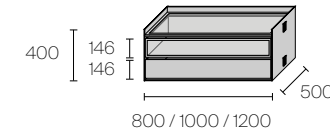

1 glass front, 1 synthetic leather front

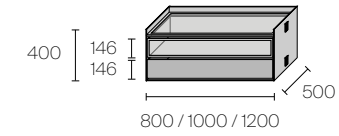

H 515 with three drawers

3 aluminium fronts

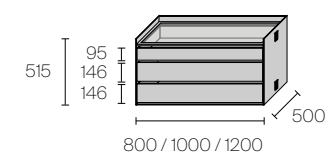

3 glass fronts

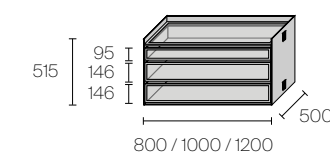

3 synthetic leather fronts

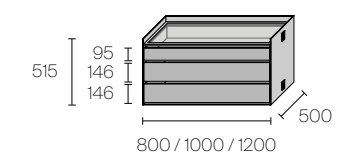

1 glass front, 2 with aluminium fronts

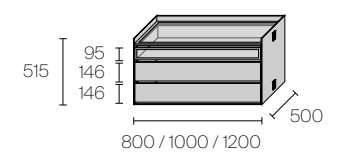

1 glass front, 2 open fronts

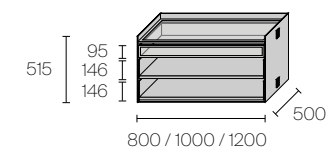

1 glass front, 2 synthetic leather fronts

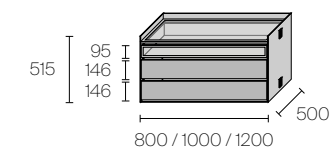

H 566 with three drawers

3 aluminium fronts

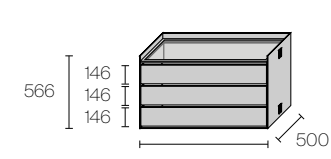

3 glass fronts

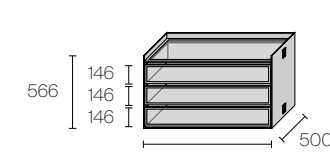

3 synthetic leather fronts

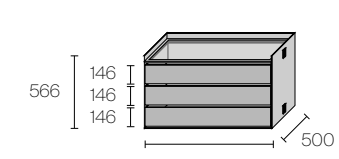

3 open fronts

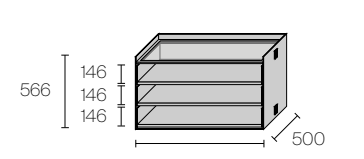

1 glass front, 2 aluminium fronts

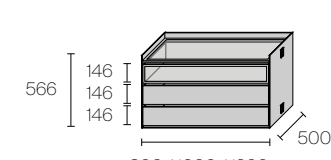

1 glass front, 2 open fronts

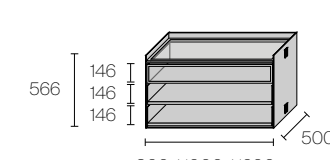

1 glass front, 2 synthetic leather fronts

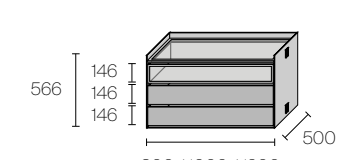

COMPONENTS AND ACCESSORIES

Suspended drawer unit in melamine

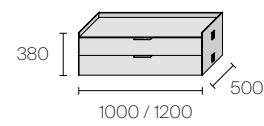

Drawer unit on wheels in melamine with 3 drawers

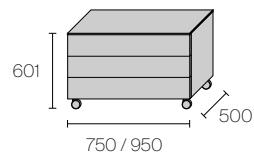

Drawer unit on wheels in melamine with 4 drawers

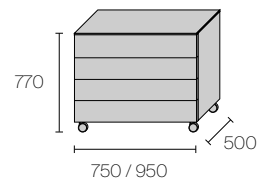

Drawer unit on wheels in lacquered glass with 4 drawers

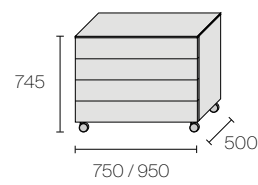

Melamine top with lining in synthetic leather

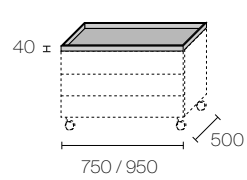

Mat for suspended drawer unit

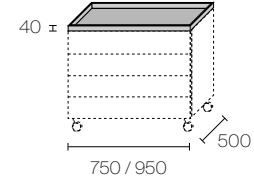

Mat for suspended drawer unit on wheels

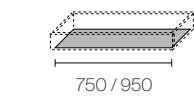
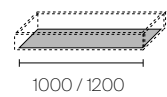

Linear shelf in glass or melamine

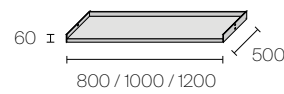

Corner shelf in glass or melamine

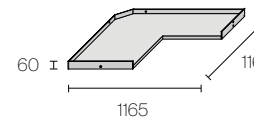

Shoe shelf in glass or melamine

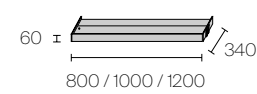

Adjustable wall thrust block

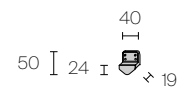

Clothes-hanger bar for linear shelf

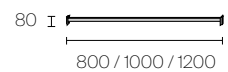

Clothes-hanger bar for corner shelf

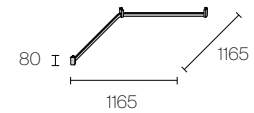

Telescopic clothes lift

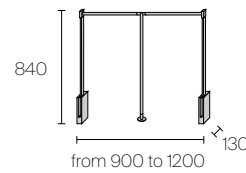

Pull-out shelf with tray in synthetic leather finishing

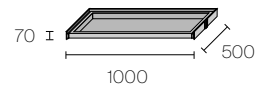

Veneered organizer

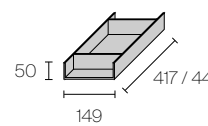

Organizer with double partition

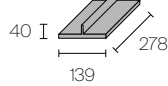

Watch holder

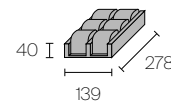

Concave box and box with jewels slots



Synthetic leather box

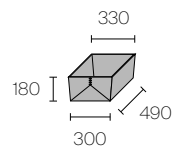

Synthetic leather tray

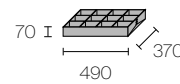

Wooden clothes hanger



Synthetic leather cabinet on wheels

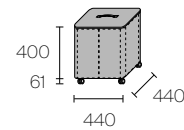

ACCESSORIES



1



2



3



4



5



6



7

1. Proposal B with accessories inside the organizer: 3 veneered organizers, 1 organizer with double partition, 1 watch holder, 2 concave boxes
2. Proposal B with accessories outside the organizer: 3 veneered organizers, 1 organizer with double partition, 1 watch holder, 2 concave boxes
3. Proposal A with accessories outside the organizer: 3 veneered organizers, 2 organizers with double partition, 1 concave box, 1 box with jewels slot
4. Proposal A with accessories inside the organizer: 3 veneered organizers, 2 organizers with double partition, 1 concave box, 1 box with jewels slot
5. Synthetic leather box
6. Synthetic leather tray
7. Synthetic leather cabinet on wheels

FINISHINGS

Structure

ALUMINIUM



Shelf and shoe shelf

TRANSPARENT GLASS



SATINATED GLASS

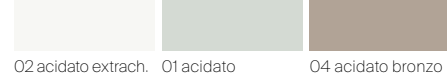

MELAMINE



SYNTHETIC LEATHER

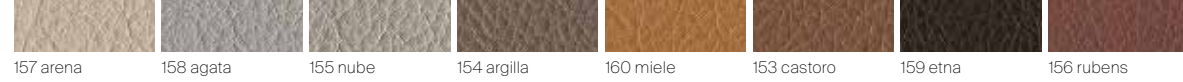

Drawer unit on wheels

LACQUERED GLASS METALIZED GLASS



DIAMANTE GLASS



MELAMINE



Melamine top with lining in synthetic leather for drawer units on wheels

SYNTHETIC LEATHER

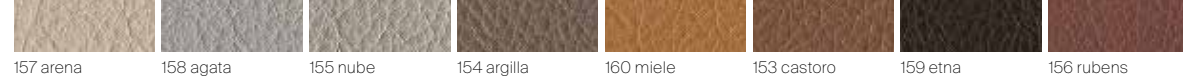

MELAMINE



Melamine suspended drawer units

MELAMINE



Box, tray and cabinet on wheels

SYNTHETIC LEATHER



Structure of suspended aluminium drawer units

ALUMINIUM



Aluminium drawer front

TRANSPARENT GLASS

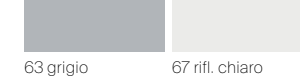

ALUMINIUM



SYNTHETIC LEATHER

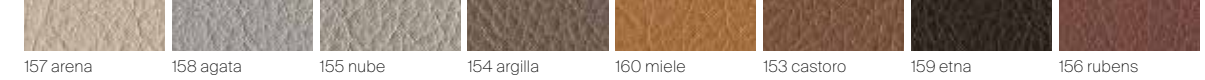

Drawer internal cladding

MATERIAL FABRIC



LUX FABRIC

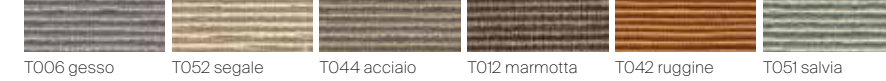

TECH FABRIC



SYNTHETIC LEATHER



INTERNAL MELAMINE*



* only available for drawer units on wheels and melamine suspended drawer units

Pull-out accessories and clothes-hanger bar

ALUMINIUM



SYNTHETIC LEATHER

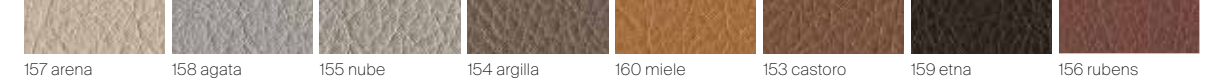

Telescopic clothes lift

ALUMINIUM

