

ALAMBRA

Rimadesio



WITH ALAMBRA, RIMADESIO GIVES A CONTEMPORARY REINTERPRETATION OF CLASSIC FURNITURE LIKE SIDEBOARDS, GLASS CABINETS AND DRAWER UNITS. A COLLECTION CHARACTERIZED BY THE PARTICULAR STRUCTURE IN ALUMINIUM, BY EXCLUSIVE DESIGN DETAILS, BY THE MECHANISMS OF MOVEMENT AND BY SHELVES EQUIPPED WITH INTEGRATED LED LIGHTING SYSTEM. A PROPOSAL AVAILABLE IN VARIOUS SIZES AND WITH DIFFERENT TECHNICAL INTERNAL EQUIPMENT.

IT Con Alambra, Rimadesio propone una reinterpretazione in chiave contemporanea di tipologie classiche dell'arredo come madie, vetrine e cassettiere. Una collezione caratterizzata dalla particolare struttura in alluminio, dal disegno esclusivo dei dettagli, dai meccanismi di movimento e dotata di illuminazione a led integrata nei ripiani. Una proposta articolata in varie dimensioni e dotata di attrezzature tecniche differenziate.

DE Mit Alambra bietet Rimadesio eine gemäßige Neuinterpretation den klassischen Möbeltypen wie Sideboard, Vitrine und Schubladen Elementen an. Eine Kollektion von der besonderer Struktur aus Aluminium charakterisiert, exklusive Design-Details, Mechanismen der Bewegung und Led-Beleuchtung integriert bei Fachböden. Einer artikulierter Vorschlag in verschiedenen Massen und mit differenzierten technischen Ausrüstungen.

FR Avec Alambra, Rimadesio propose une réinterprétation contemporaine de meubles comme les bahuts, les vitrines et les blocs tiroirs. Une collection caractérisée par une particulière structure en aluminium, par des détails exclusifs de design, par mécanismes de mouvement et équipée de système d'éclairage à led intégré dans les étagères. Une proposition disponible en différentes dimensions et avec équipements différents.

ES Con Alambra, Rimadesio ofrece una reinterpretación contemporánea de tipologías clásicas de mobiliario como aparadores, vitrinas y cajoneras. Una colección que se caracteriza por la estructura particular en aluminio, de diseño exclusivo de los detalles, de los mecanismos de movimiento y dotada de iluminación por leds integrada en los estantes. Una propuesta que se articula en varios tamaños y con interiores diferentes.

RU Компания Rimadesio предлагает современное переосмысление классических типов мебели — шкафов, витрин и тумб — новой коллекции Alambra. Коллекция отличается особой алюминиевой конструкцией, эксклюзивным дизайном деталей, механизмами Открывания и светодиодной подсветкой, встроенной в полки. Коллекция представлена в различных размерах и с Различным внутренним оснащением.

汉语 Rimadesio 通过 Alambra 掌握橱柜、展示柜和抽屉柜等经典家具的现代调性并重新诠释。系列特色为特殊的铝合金架构、独特的设计细节与多样的移动装置·LED 照明装置嵌入于层板之中。该产品系列提供多种尺寸并附有不同的技术配件。



STORAGE UNIT SYSTEMS / ALAMBRA

Structure: 13 nero
Glass: 63 grigio trasparente
Internal: 19 rovere termotrattato
W 2616 H 1516 D 500

In this photo
Wall panelling system: Modulor

EN Available with or without crosspieces, entirely made in extruded aluminium, the project of the Alambra door is focusing the attention on details, typical of all the Rimadesio proposals. The precision of the opening movement, the innovation introduced by the closing system with neodymium magnets, the absence of visible screws, joints and plastic gaskets are the results of an exclusive technical research.

IT Disponibile con o senza traversini, interamente realizzata in alluminio estruso, l'anta di Alambra è un progetto in cui si concentra l'attenzione al dettaglio tipica della proposta Rimadesio. La precisione del movimento di apertura, l'innovazione introdotta dal sistema di chiusura con magneti al neodimio, la totale assenza di viti, giunzioni e guarnizioni in plastica sono il risultato di una ricerca tecnica esclusiva.

DE Die Tuer von Alambra aus extrudiertem Aluminium ist mit oder ohne Sprossen erhaeltlich. Rimadesio konzentriert sich auch auf Details. Die Genauigkeit der Oeffnung der Tuer, die Innovation der Schliessung mit Magneten in Neodym, keine Sichtschrauben und Verbindungsteile aus Kunststoff sind das Ergebnis der exklusiven technischen Forschung die her bei Firma Rimadesio gemacht wurde.

FR La porte de Alambra, disponible avec ou sans traverses, entièrement en aluminium extrudé, est un projet dédié à l'attention du détail, caractéristique commune à toutes les propositions Rimadesio. La précision du mouvement d'ouverture, la nouveauté introduite par le système de fermeture avec des aimants de néodyme, l'absence totale de vis et joints en plastique, même à son intérieur, sont également le résultat d'une recherche technique très exclusive.

ES Disponible con o sin travesaños, hecha enteramente en aluminio extruido, la puerta de Alambra es un proyecto en que se centra la atención al detalle típica de la propuesta Rimadesio. La precisión del movimiento de apertura, la innovación introducida por el sistema de cierre con imanes de neodimio, la total ausencia de tornillos, juntas y gomas también en el interior son el resultado de una búsqueda técnica exclusiva.

RU Дверь Alambra, изготовленная полностью из экструдированного алюминия, доступна с поперечными перемычками или без них, — это дизайн, в котором максимально сконцентрировано внимание к деталям, характерное для Rimadesio. Точность механизма открывания, инновационная система запираия с неодимовыми магнитами, полное отсутствие винтов, соединений и пластиковых уплотнителей — все это результат эксклюзивных технических исследований.

汉语 Alambra 的门扇以全挤出铝合金制成，带横挡或不带横挡皆可，在这其中 Rimadesio 倾注了对设计细节一贯的重视。开启门扇的精确运动搭配新引进的钕磁铁闭合系统，完全舍弃螺钉、连接件和塑料垫圈，上述皆为独家技术的研究成果。





EN The Alambra bar is a unit with built-in refrigerator, fitted with open compartments and doors in noce, rovere termotrattato and rovere nero. The tops, handles and trays are available in synthetic leather in the 8 colours from the Rimadesio sample collection. An integrated LED lighting system is also provided.

IT La versione Alambra bar è un mobile con frigorifero interno, dotato di vani a giorno ed anta in legno noce, rovere termotrattato e rovere nero. I top, le maniglie e i vassoi sono disponibili in similpelle negli 8 colori a campionario Rimadesio. È previsto inoltre un sistema illuminazione a led integrato.

DE Die Barversion von Alambra ist ein Schrank mit einem Kühlschrank im Inneren, der mit offenen Fächern und Türen aus Noce, Rovere Termotrattato und Rovere Nero ausgestattet ist. Die Oberteile, Griffe und Tablets sind aus Kunstleder in den 8 Rimadesio-Musterfarben erhältlich. Ein integriertes LED-Beleuchtungssystem ist ebenfalls vorgesehen.

FR La version Alambra bar est un meuble avec réfrigérateur intégré, équipé de compartiments ouverts et d'une porte en noce, rovere termotrattato et rovere nero. Les plateaux, poignées et tablettes sont disponibles en similcuir dans les 8 couleurs du nuancier Rimadesio. Un système d'éclairage LED intégré est également prévu.

ES La versión bar Alambra es un mueble con frigorífico interno, equipado con compartimentos abiertos y puertas de madera noce, rovere termotrattato y rovere nero. Los tops, los tiradores y las bandejas están disponibles en simil cuero, en los ocho colores del muestrario de Rimadesio. También se proporciona un sistema de iluminación LED integrado.

RU Барная версия Alambra — это шкаф со встроенным холодильником, оснащенный открытыми отделениями и Дверцей из орехового дерева, термообработанного Или черного дуба. Столешницы, ручки и Лотки предлагаются с отделкой из искусственной кожи в 8 цветовых вариантах Rimadesio. Также предусмотрена встроенная система светодиодного освещения.

汉语 Alambra 版本的酒吧柜内设有冰箱、开放式收纳空间搭配以胡桃木、热处理橡木和黑橡木打造的门扇。台面、把手和托盘以仿真皮革包覆，在 Rimadesio 的样品集中共有 8 种颜色可供选择。除此之外，亦可配置集成 LED 照明系统。

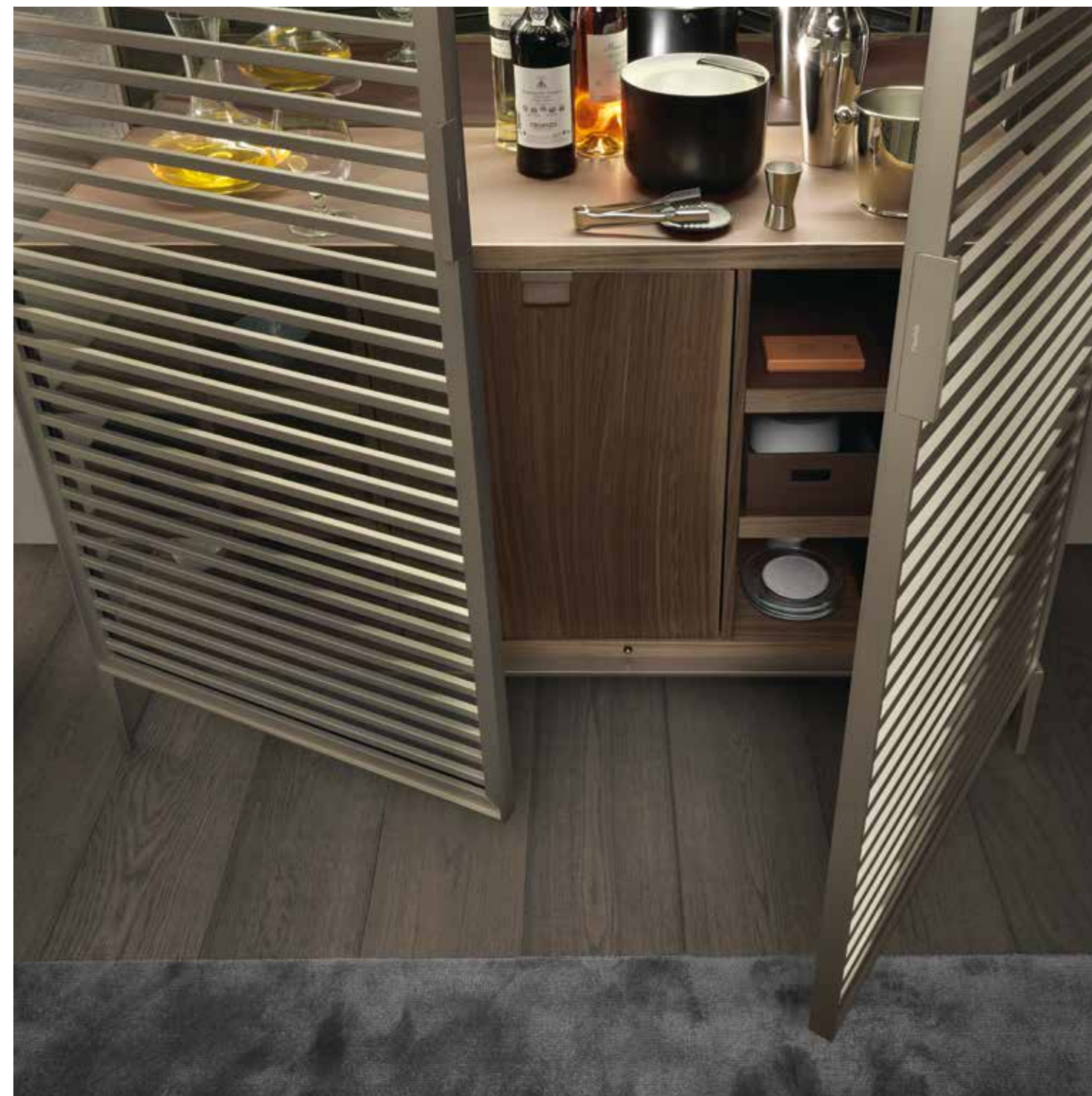

BAR UNIT
Structure: 304 platino
Doors, sides and shelf: 63 grigio trasparente
Back panel: 68 specchio grigio
Top: 137 platino opaco
W 1308 H 1659 D 500



STORAGE UNIT SYSTEMS / ALAMBRA

MONETIERE
Structure: 303 bronzo
Glass: 81 riflettente bronzo
Drawers and internal structure: 15 noce
W 1008 H 1553 D 500



Structure: 13 nero
Doors: 03 acidato grigio
Top: 102 nero opaco
Side and back panels: 64 riflettente grigio
W 2616 H 833 D 500

STORAGE UNIT SYSTEMS / ALAMBRA



Structure: 14 brown
Glass: 03 acidato grigio
Top: 99 caffè opaco
Drawers: 19 rovere termotrattato
Internal shelf: 63 trasparente grigio
W 2616 H 833 D 500

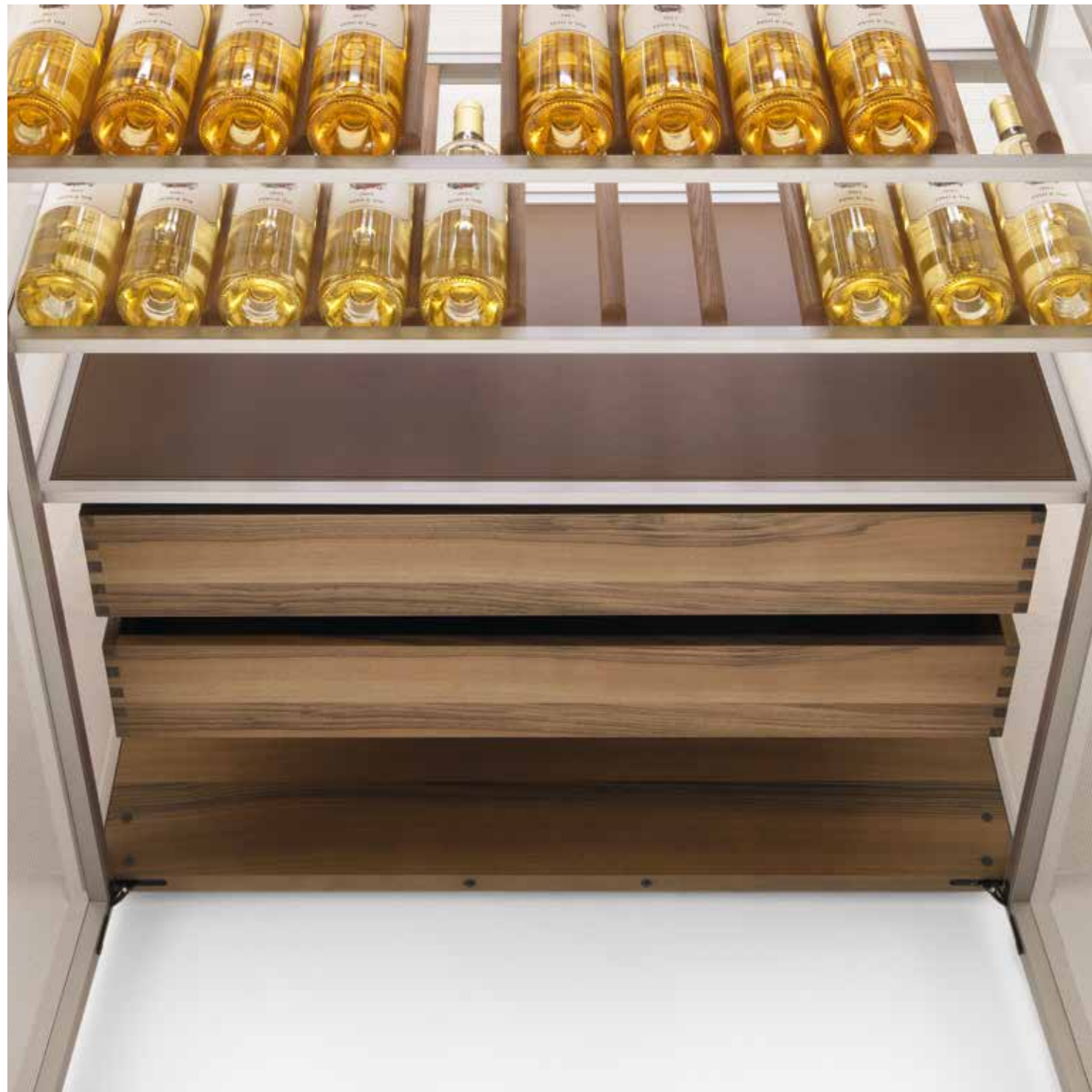



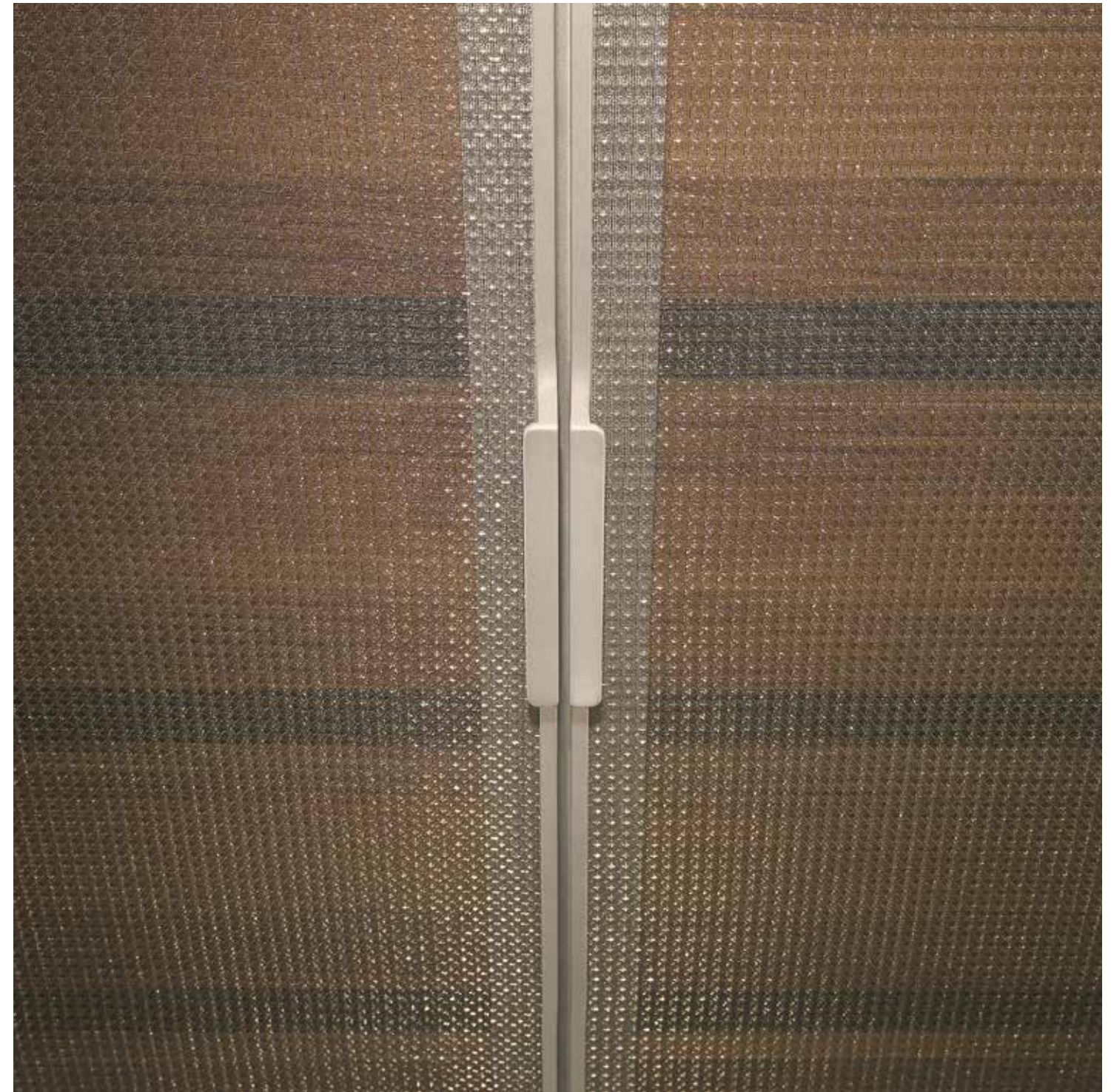

STORAGE UNIT SYSTEMS / ALAMBRA

Structure: 304 platino
Doors, sides and back panel: 08 fibra bronzo
Shelf: 63 grigio trasparente
Drawers and floor base: 15 noce
W 1008 H 1516 D 500







STORAGE UNIT SYSTEMS / ALAMBRA

SIDEBOARD WITH TRANSPARENT TOP
AND INTERNAL SHELF
Structure: 304 platino
Glass: 64 riflettente grigio
Base: 15 noce
Internal shelf: 63 grigio trasparente
W 2016 H 833 D 500





EN Alambra Isola is a free-standing display cabinet specifically designed for bedrooms and retail spaces. The top is available in transparent satin, diamante and glossy or matt lacquered glass; the fittings are in noce wood and synthetic leather. The internal back panel is in grey mirror glass.

IT Alambra isola è un mobile espositore centrostanza appositamente studiato per la zona notte e per gli spazi retail. Il top è disponibile in vetro trasparente satinato, diamante e laccato lucido o opaco; le attrezzature sono in essenza noce e similpelle. Lo schienale interno è in specchio grigio.

DE Alambra isola ist ein speziell für das Schlafzimmer und den Verkaufsraum konzipiertes Möbelstück. Die Oberfläche ist aus transparentem, satiniertem, diamante und glänzend oder matt lackiertem Glas erhältlich; die Beschläge sind aus Noce und Kunstleder. Die Rückwand im Inneren ist aus einem grauen Spiegel gestaltet.

FR Alambra isola est une vitrine autoportante spécialement conçue pour l'espace nuit et les espaces commerciaux. Le plateau est disponible en verre transparent satiné, diamante et laqué brillant ou mat; les équipements sont en bois noce et similicuir. Le fond intérieur est gris réfléchissant.

ES Alambra isla es un mueble expositor independiente diseñado específicamente para dormitorios y espacios comerciales. El top está disponible en cristal transparente satinado, diamante y lacado brillante o mate; el equipamiento está fabricado en madera noce y símil cuero. La parte trasera interior es de espejo gris.

RU Остров из коллекции Alambra — это центральная витрина, специально разработанная для спальни и торговых залов. Столешница доступна в прозрачном сатинированном, бриллиантовом, глянцевом или матовом лакированном стекле; фурнитура — из орехового дерева и кожзаменителя. Внутренняя часть стеновой панели выполнена из серого зеркала.

汉语 Alambra Isola 是一款独立的展示柜，专为卧室和零售空间所设计。台面可采用透明缎面、Diamante、亮面漆和哑光漆等玻璃表面处理；配件材质有胡桃木和仿真皮革可供选择。内部背板为灰色镜面。



ALAMBRA ISOLA
MIDDLE ROOM DISPLAY UNIT
Structure and base: 303 bronzo
Glass: 67 riflettente chiaro
Drawers: 15 noce
Drawer internal lining: 153 castoro
Internal back: 68 specchio grigio
Glass shelves: 63 grigio trasparente
W 2016 H 833 D 939



STORAGE UNIT SYSTEMS / ALAMBRA

SUSPENDED CABINET WITH FLAP DOOR
Structure: 13 nero
Glass door and sides: 490 trasparente diamante
Back panel: 68 specchio grigio
Internal top: 102 nero opaco
W 1603 H 386 D 316

In this photo
Shelf: Eos
Suspended cabinet: Self plan
Coffee table: Tray
Sliding door: Stripe



STORAGE UNIT SYSTEMS / ALAMBRA

SUSPENDED CABINET WITH FLAP DOOR
Structure: 13 nero
Glass door and sides: 490 trasparente diamante
Back panel: 68 specchio grigio
Internal top: 102 nero opaco
W 1603 H 386 D 316

In this photo
Shelf: Eos



STORAGE UNIT SYSTEMS / ALAMBRA

SUSPENDED CABINET WITH FLAP DOOR
Structure: 303 bronzo
Door, sides and top: 67 riflettente chiaro
Internal top: 303 bronzo lucido
Back panel: 68 specchio grigio
W 1538 H 386 D 316

In this photo
Table: Long Island

EN The suspended cabinet is equipped with an exclusive invisible mechanism for the opening of the flap door, specifically designed for this refined wall version, the result of Rimadesio's technological research. The led lighting system of latest generation is embedded in the horizontal aluminum profiles.

IT La vetrina pensile è dotata di un esclusivo meccanismo invisibile per l'apertura dell'anta ribalta, specificatamente progettato per questa raffinata versione a parete, frutto della ricerca tecnologica Rimadesio. L'illuminazione led di ultima generazione è incassata nei profili orizzontali in alluminio.

DE Die Hängevitrine ist mit einem exklusiven unsichtbaren Mechanismus für das Öffnen der Klapptür ausgestattet. Letzterer ist das Ergebnis der technologischen Forschung Rimadesios, das speziell für diese raffinierte Wandversion ausgelegt ist. Die Led-Beleuchtung der neuesten Generation ist in die horizontalen Aluminiumprofile eingebettet.

FR La vitrine suspendue est équipée d'un exclusif mécanisme invisible pour l'ouverture de la porte abattante, spécialement conçu pour cette version murale raffinée, comme résultat de la recherche technologique Rimadesio. L'éclairage led de dernière génération est intégré dans les profilés horizontaux en aluminium.

ES La vitrina colgante está equipada de un exclusivo mecanismo invisible para la apertura de la puerta abatible, específicamente diseñado para esta versión refinada a pared, resultado de la investigación tecnológica de Rimadesio. La iluminación led de última generación está integrada en los perfiles horizontales en aluminio.

RU Настенная витрина оснащена эксклюзивным невидимым механизмом открывания откидной дверцы, специально разработанным для этой изысканной версии, являющейся результатом технологических исследований Rimadesio. Современное светодиодное освещение встроено в горизонтальные алюминиевые профили.

汉语 壁挂式玻璃展示柜配备独家的隐形翻门开启装置，该装置是Rimadesio 的技术研究成果，专为这款精致的壁挂款式而设计。最新一代的LED照明装置嵌入呈水平的铝合金轮廓中。

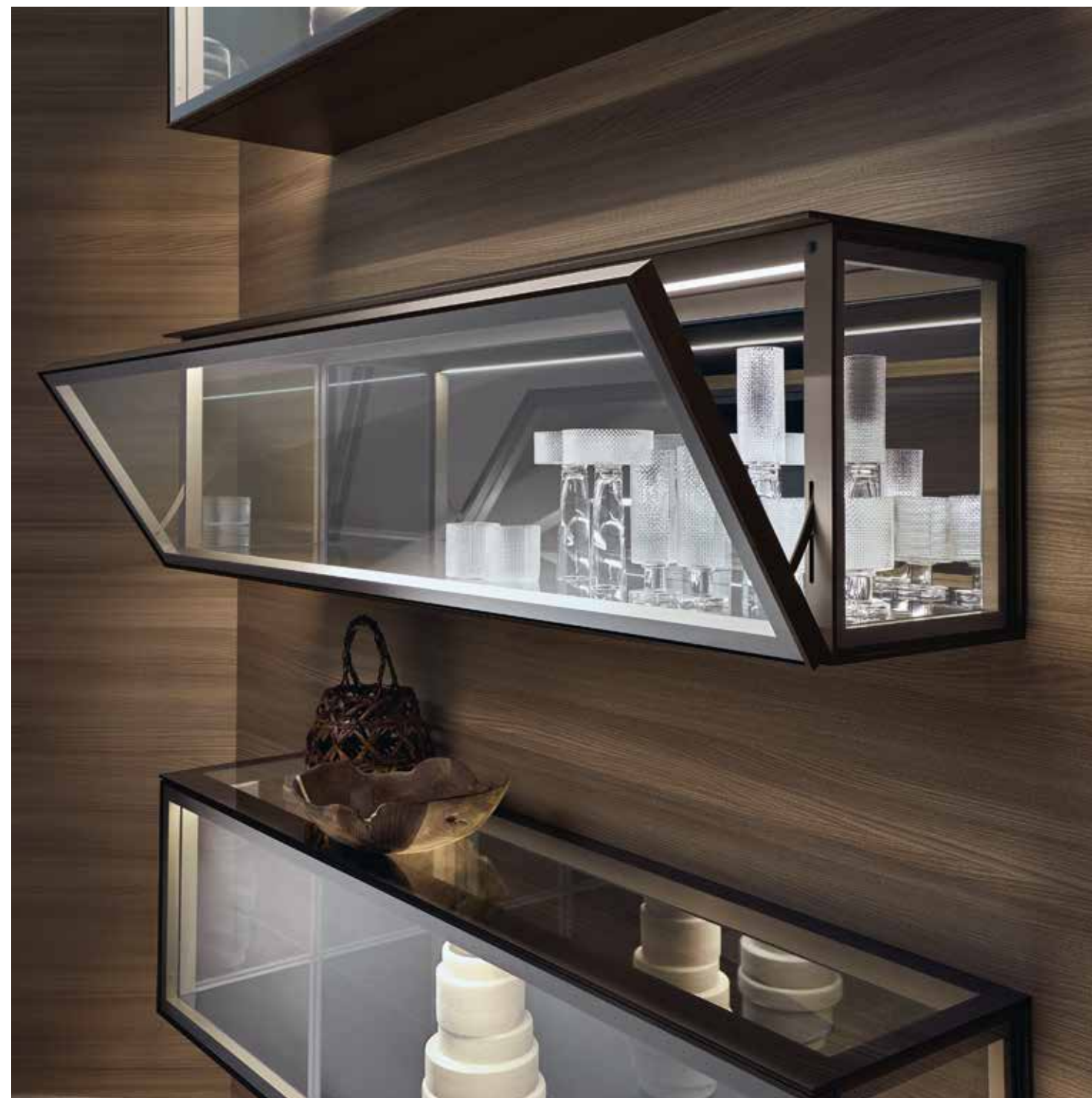

SUSPENDED CABINET WITH FLAP DOOR
Structure: 303 bronzo
Door, sides and top: 67 riflettente chiaro
Internal top: 303 bronzo lucido
Back panel: 6B specchio grigio
W 1538 H 386 D 316



STORAGE UNIT SYSTEMS / ALAMBRA



SUSPENDED CABINET WITH FLAP DOOR
 Structure: 304 platino
 Door, sides and top: 67 riflettente chiaro
 Internal top: 137 platino opaco
 Back panel: 68 specchio grigio
 W 1603 H 386 D 316

In this photo
 Wall panelling system: Modulor
 Coffee table: Tray



STORAGE UNIT SYSTEMS / ALAMBRA

SUSPENDED CABINET WITH HINGED DOOR
Structure: 303 bronzo
Door and side panels glass: 67 riflettente chiaro
Back panel: 68 specchio grigio
Shelves: 63 grigio trasparente
Internal drawer: 15 noce
Synthetic leather for top and drawer lining: 153 castoro
W 424 H 1604 D 338

In this photo
Wall panelling system: Modulor
Table: Manta



MODULARITY

Version with floor base

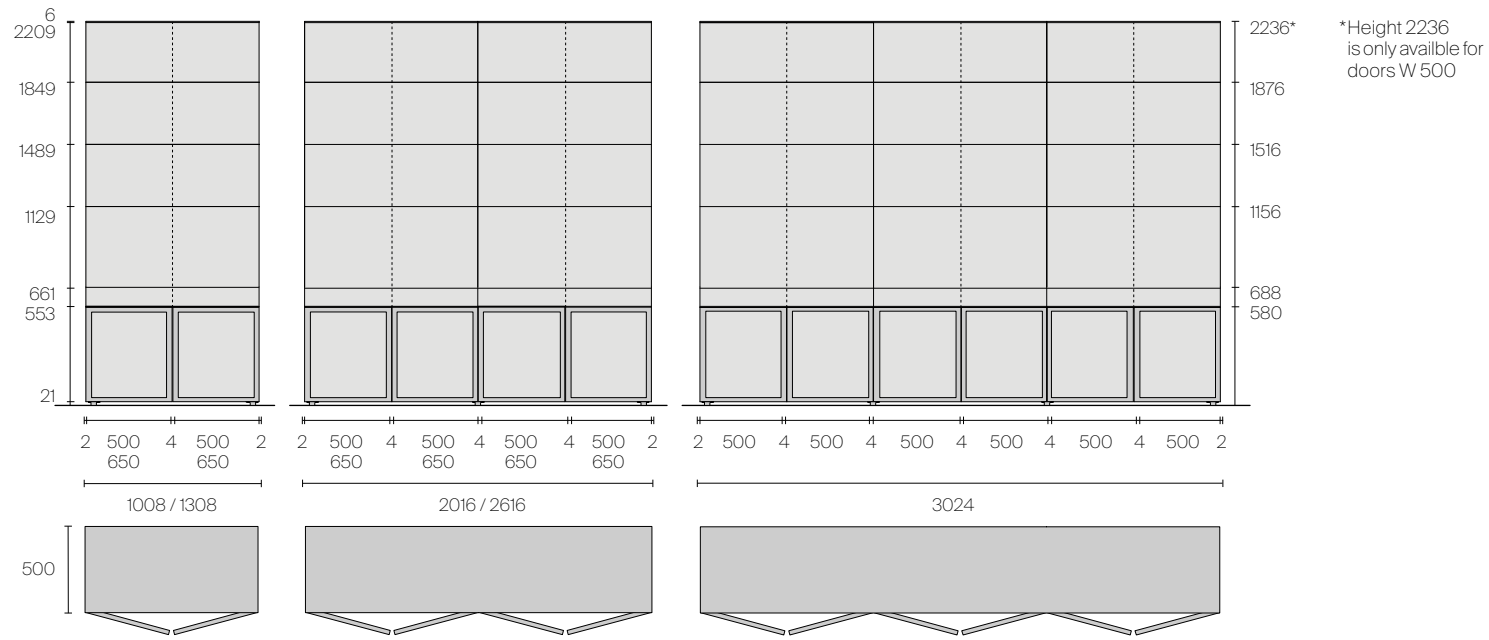

Version with legs

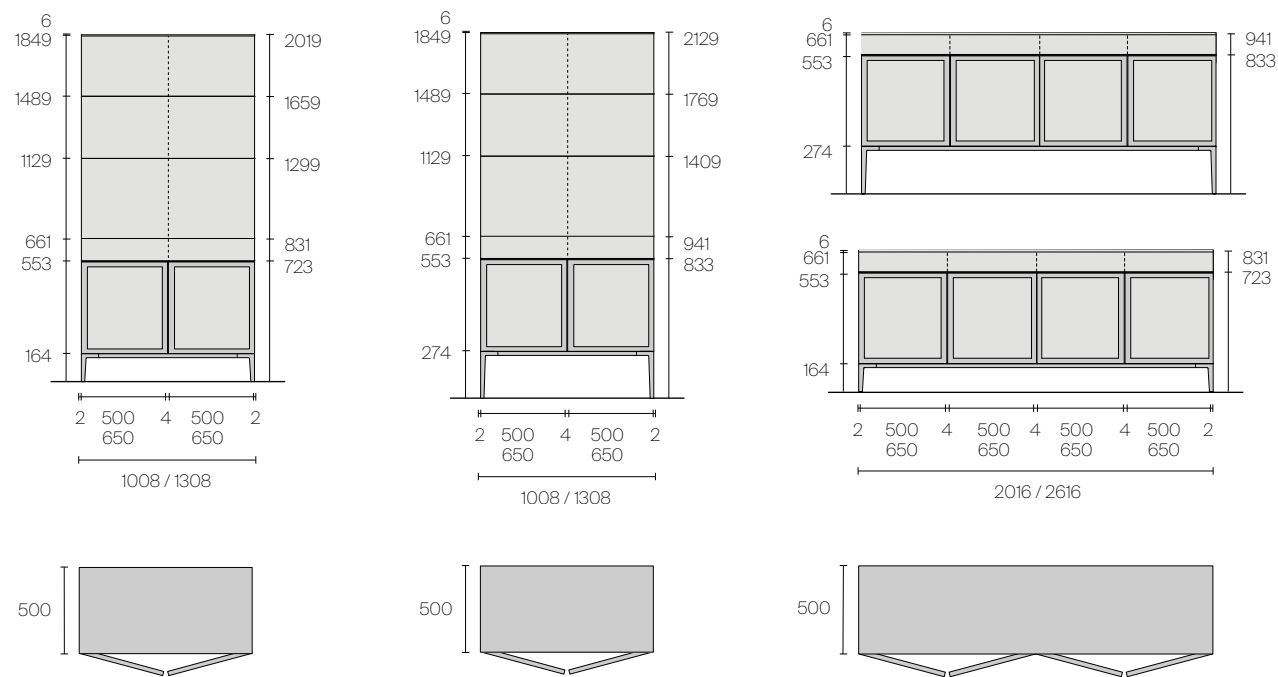

COMPONENTS AND ACCESSORIES

Side panel in tempered glass with aluminum frame

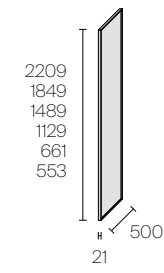

Glass back panel

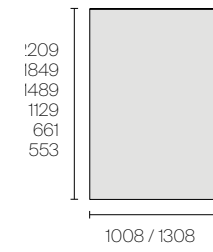

Central upright in extruded aluminum

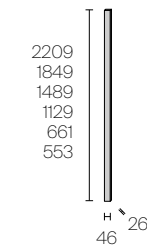

Glass door with or without crosspieces

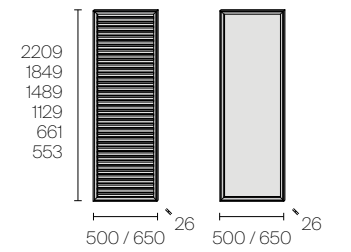

Wooden floor base

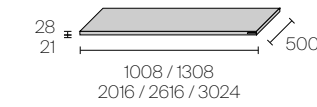

Base with legs H 164 or H 274

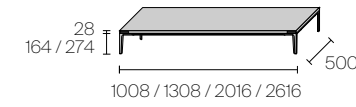

Wooden and mat lacquered glass top

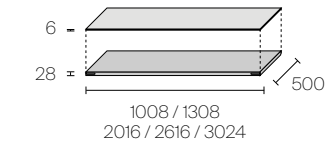

Glass top

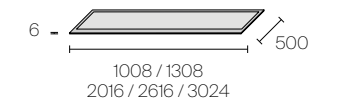

Wooden drawer unit on base

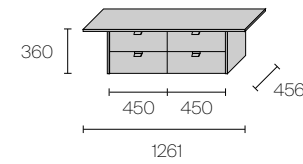
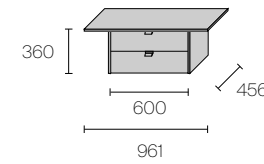

Suspended wooden drawer units

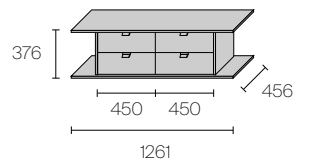
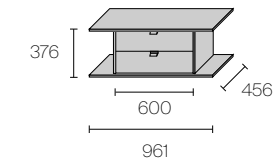

Suspended drawer

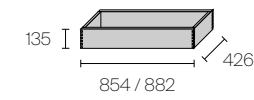

Wooden undertop drawer

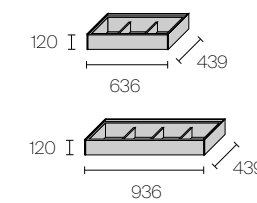

Internal glass shelf

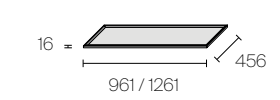

Bottle rack

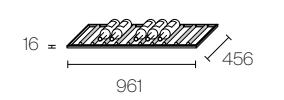

Led lighting for wooden top, glass shelf, suspended unit and bottle rack

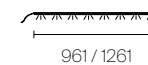

Front and back led lighting for glass top

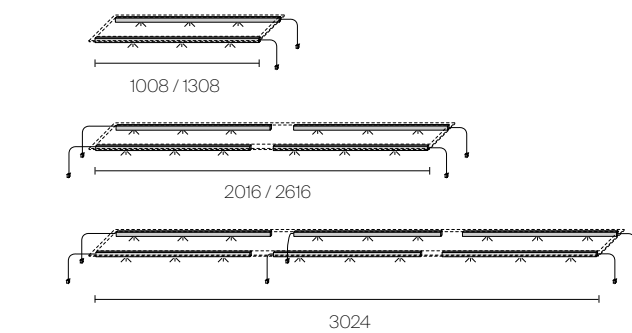

Fridge bar unit

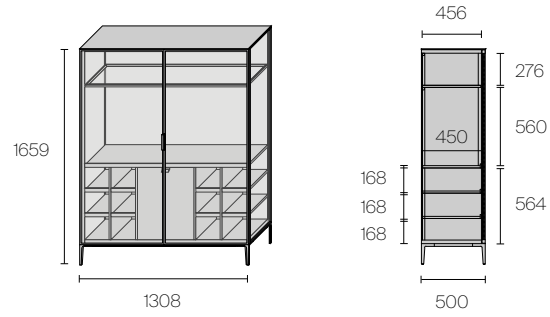

Monetiere

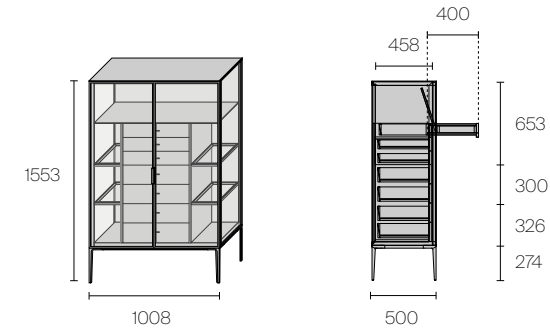

Isola: middle room display unit with glass top

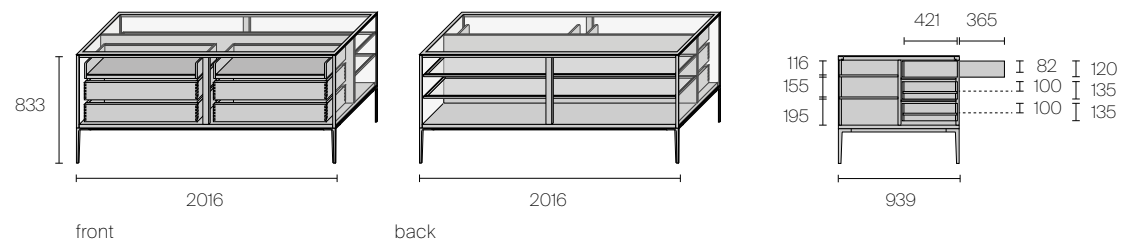

Case sideboard with suspended tray and drawers

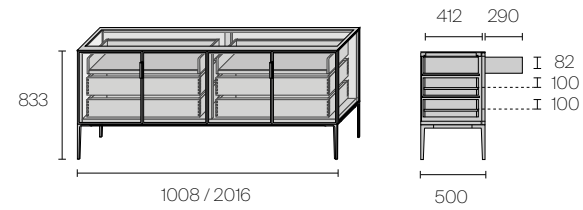

Case sideboard with suspended shelf and drawers

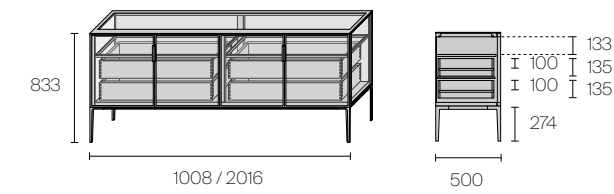

Case sideboard with drawer unit on base

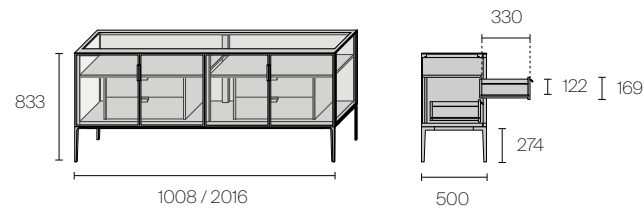

Case sideboard with shelf



Suspended glass cabinet with hinged door

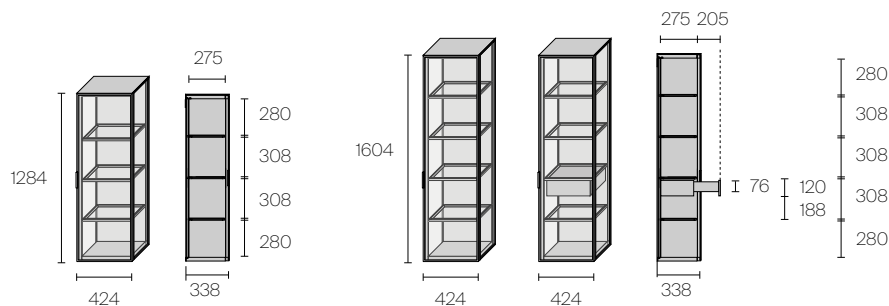

Suspended glass cabinet with flap door

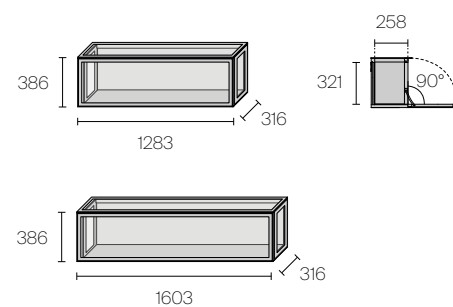

- 1. Handle
- 2. Handle with lock
- 3. Glass door

1

2



3

TECHNICAL DESCRIPTION

EN Alambra is a double-sided system in aluminium and glass with top, cabinets and base in wood available in three varieties: noce, rovere termotrattato and rovere nero. Alternatively, the top can be made of transparent glass. The structure is available in brown, nero, platino and bronzo aluminium. The doors, sides, back panels and shelves are made of tempered glass.

FR Alambra est un système double face en aluminium et verre avec plateau, éléments de rangement et base en bois, disponible en trois essences: noce, rovere termotrattato et rovere nero. Le dessus peut aussi être réalisé en verre transparent. La structure est disponible en aluminium brown, nero, platino et bronzo. Les portes, côtés, fonds et étagères sont en verre trempé.

RU Alambra — это двусторонняя система из алюминия и стекла с деревянной столешницей, ящиками для хранения и цоколем из трех пород дерева: ореха, черного дуба и термообработанного дуба. В качестве альтернативы верхняя часть может быть выполнена из прозрачного стекла. Конструкция доступна из алюминия коричневого, черного, платинового и бронзового цвета. Дверцы, стеновые панели и полки выполнены из закаленного стекла.

IT Alambra è un sistema bifacciale in alluminio e vetro con top, contenitori e basamento in legno disponibile in tre essenze: noce, rovere termotrattato e rovere nero. Il top, in alternativa, può essere realizzato in vetro trasparente. La struttura è disponibile in alluminio brown, nero, platino e bronzo. Ante, spalle, schienali e ripiani sono realizzati in vetro temperato.

ES Alambra es un sistema a doble cara de aluminio y vidrio con top, contenedores y base de madera disponible en tres maderas: noce, rovere termotrattato y rovere nero. El top también puede ser de cristal transparente. La estructura está disponible en aluminio brown, nero, platino y bronzo. Las puertas, los laterales, las partes traseras y los estantes están hechos con vidrio templado.

汉语 Alambra 是一款采用铝合金和玻璃材质打造的双面设计系统，其包含台面、收纳空间和以木材打造的底座，有三种木材可供选择：胡桃木、黑橡木和热处理橡木。台面亦能以透明玻璃制作。柜体材质有棕、黑、铂金和青铜色的铝合金可供选择。门片、侧板、背板和层板采用钢化玻璃打造。

DE Alambra ist ein beidseitiges System aus Aluminium und Glas mit einer Holzplatte, Behältern und einem Sockel, der in drei Holzarten erhältlich ist: Noce, Rovere Termotrattato und Rovere Nero. Die Oberseite ist alternativ aus transparentem Glas gefertigt. Das Gestell ist in Brown, Nero, Platino und Bronzo Aluminium erhältlich. Türblätter, Rückwände und Einlegeböden sind aus gehärtetem Glas gefertigt.

FINISHINGS

Structure

ALUMINIUM



Base, internal equipment

WOOD

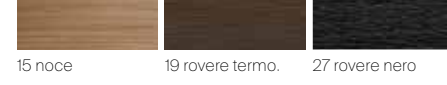

Undertop drawer, internal drawer, accessories

SYNTHETIC LEATHER

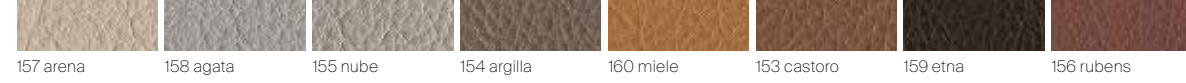

WOOD

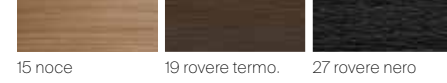

Glass and wooden top

LACQUERED GLASS

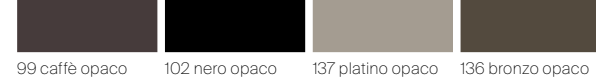

WOOD

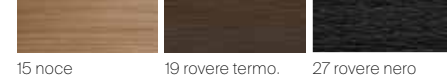

Glass top

LACQUERED GLASS

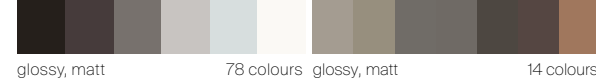

TRANSPARENT GLASS

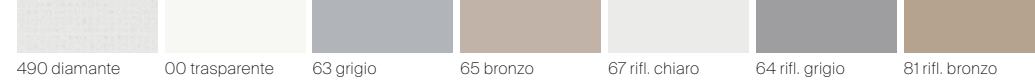

SATINATED GLASS

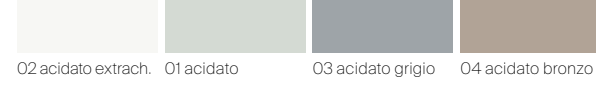

Internal shelf

LACQUERED GLASS



TRANSPARENT GLASS

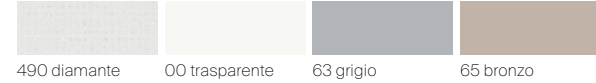

SATINATED GLASS

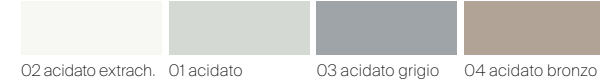

SYNTHETIC LEATHER



Back panel

LACQUERED GLASS



REFLEX GLASS



DIAMANTE GLASS



MESH GLASS



TRANSPARENT GLASS

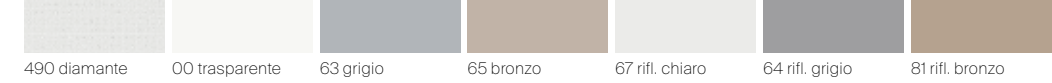

SATINATED GLASS

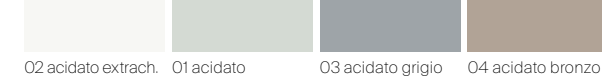

NEUTRAL GLASS

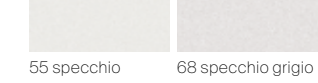

Doors and side panels

LACQUERED GLASS

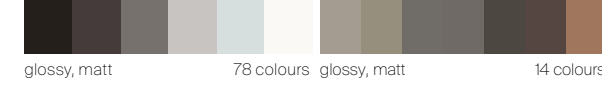

REFLEX GLASS

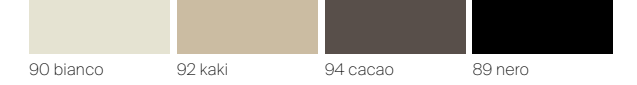

DIAMANTE GLASS



MESH GLASS*



TRANSPARENT GLASS

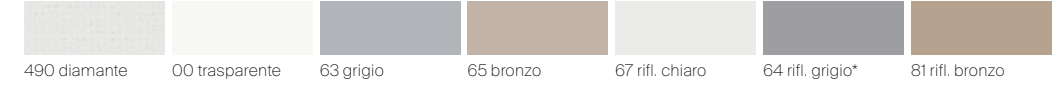

SATINATED GLASS

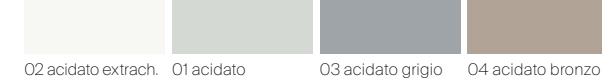

* not available for door with crosspieces

MONETIERE FINISHINGS

Structure

ALUMINIUM



Glass and wooden top

LACQUERED GLASS

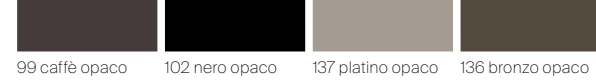

METALIZED GLASS

WOOD



Glass top

LACQUERED GLASS



METALIZED GLASS

TRANSPARENT GLASS

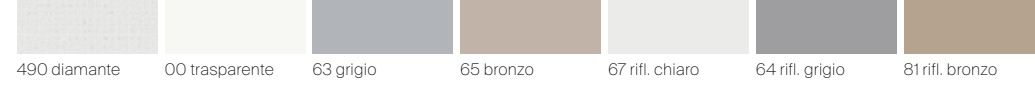

SATINATED GLASS



Internal shelf

LACQUERED GLASS



METALIZED GLASS

TRANSPARENT GLASS

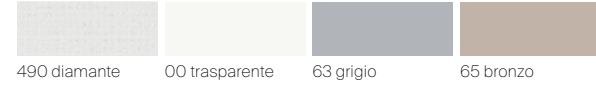

SATINATED GLASS

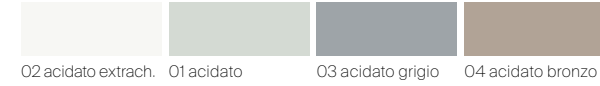

SYNTHETIC LEATHER

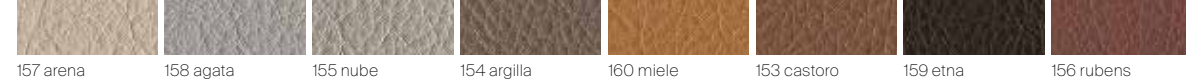

Internal drawer unit

WOOD



Internal drawer

SYNTHETIC LEATHER



Back panel

LACQUERED GLASS

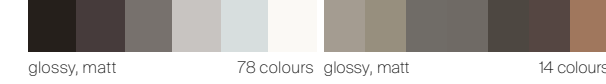

METALIZED GLASS

REFLEX GLASS



DIAMANTE GLASS



MESH GLASS

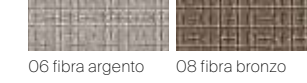

TRANSPARENT GLASS

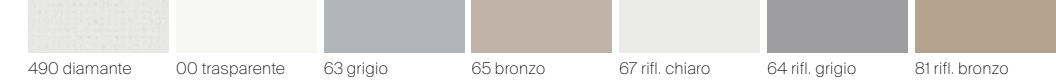

SATINATED GLASS

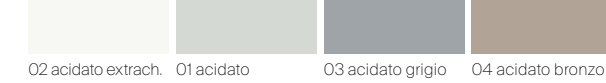

NEUTRAL GLASS

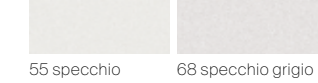

Doors and side panels

LACQUERED GLASS

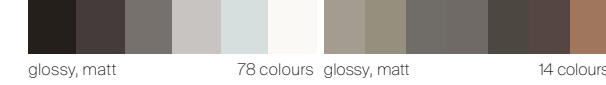

METALIZED GLASS

REFLEX GLASS



DIAMANTE GLASS



MESH GLASS*

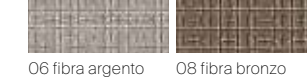

TRANSPARENT GLASS

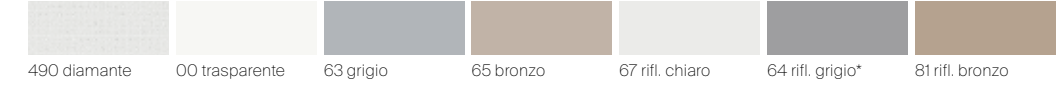

SATINATED GLASS

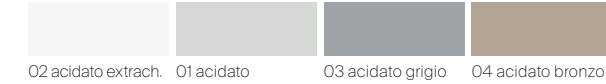

* not available for door with crosspieces

ISOLA AND CABINET FINISHINGS

Structure

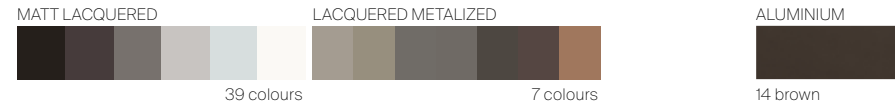

Drawer



Drawer internal lining

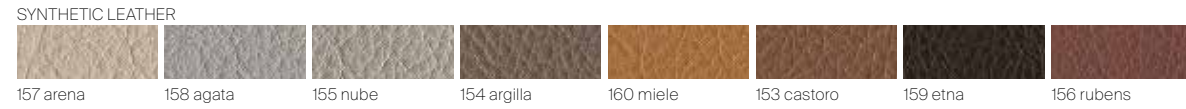

Isola side panels and top

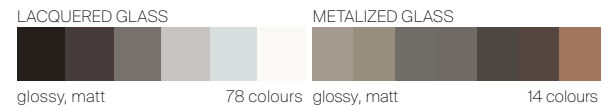

Isola shelves



Isola back panel



Cabinet doors and side panels

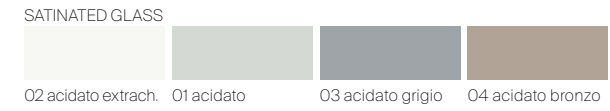
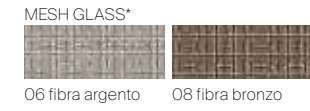
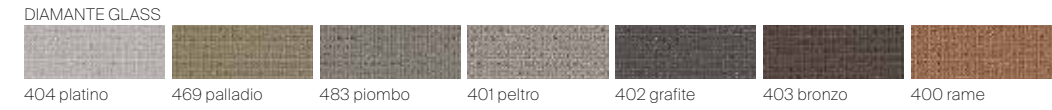

* not available for door with crosspieces

Cabinet back panel



Cabinet shelves

