

ZENIT

Rimadesio



THE ICONIC BOOKCASE IN THE PURSUIT OF LIGHTNESS AND PROJECT VERSATILITY. THE UPRIGHTS, FIXED FROM FLOOR TO CEILING AND ALWAYS CUSTOM-MADE, ALLOW A FREE POSITIONING OF THE ELEMENTS, IN THE DESIRED NUMBER AND AT THE DESIRED HEIGHT. THE EXCLUSIVE HOOKING SYSTEM ELEMENT GUARANTEES THE MAXIMUM STRUCTURAL SOLIDITY AND ALLOWS TO LEVEL EVERY ELEMENT.

IT La libreria all'insegna della leggerezza e della versatilità compositiva. I montanti, fissati da terra a soffitto e sempre su misura, permettono una libera disposizione delle attrezzature, nel numero e all'altezza desiderata. Un progetto versatile, pensato per esporre e contenere, destinato alla casa e agli spazi professionali. La varietà delle finiture, dal vetro alle essenze fino alle superfici in alluminio, consente una perfetta integrazione stilistica in ogni ambiente.

DE Das Bücherregal zeichnet sich durch Leichtigkeit und Vielseitigkeit aus. Die in Sondermaßen Pfosten, vom Boden bis zum Decke fixiert, ermöglichen dem Kunden eine freie Anordnung der Ausrüstung, in der gewünschten Anzahl und Höhe. Dies ist ein vielseitiges, für den häuslichen und professionellen Raum bestimmtes Modell, das entworfen wurde, um hergezeigt zu werden und um etwas zu verstauen. Die Vielfalt an Oberflächenmaterialien, von Glas über Holz bis zu den Aluminium-oberflächen, ermöglicht eine perfekte stilistische Integration in jeder Umgebung.

FR La bibliothèque caractérisée par la légèreté et la polyvalence de la composition. Les montants, fixés du sol au plafond et toujours sur mesure, permettent une disposition libre de l'équipement, dans le nombre et à la hauteur désirées. Un projet polyvalent, conçu pour exposer et contenir, destiné à la maison et aux espaces professionnels. La variété des finitions, du verre au bois, aux surfaces en aluminium, permet une intégration stylistique parfaite dans chaque environnement.

ES La librería se caracteriza por su ligereza y versatilidad compositiva. Los montantes, fijados al suelo y techo y siempre a medida, permiten una disposición libre del equipamiento, en el número y altura deseados. Un proyecto versátil, diseñado para exhibir y contener, destinado para el hogar y espacios profesionales. La variedad de acabados, del vidrio a las esencias y superficies de aluminio, permite una perfecta integración estilística en cualquier entorno.

RU Библиотека, характеризующаяся легкостью и композиционной универсальностью. Стойки, закрепленные в пол и потолок в полном соответствии с размерами заказчика, позволяют свободно размещать оснащение в нужном количестве и на нужной высоте. Универсальный дизайн, предназначенный для экспонирования и хранения, идеально впишется в домашний и профессиональный интерьер. Благодаря разнообразию вариантов отделки – от стекла до дерева и алюминиевых поверхностей – они могут идеально гармонировать с любым интерьером.

汉语 Zenit 书柜以轻巧和多样组合性著称。立柱皆按尺寸定制，固定于地板和天花板两端，可根据所需的配件数量和高度自由配置。多样的玻璃与木材表面处理以及铝合金打造的表面为任何空间皆能营造出完美风格感。



BOOKCASES / ZENIT

Structure: 13 nero
Glass shelves: 63 grigio trasparente
Fronts: 700 tinto ebano taiga
Marble top: 183 noir saint laurent
W 5090 H 2655 D 500

In this photo
Table: Long Island
Wall panelling system: Modolor

EN In the bookcase version, Zenit expands its design potential with the introduction of a brand new backlit upright and new suspended cabinets which, like all Zenit accessories, can be freely positioned. The aluminium drawers with fully extractable runners are equipped with a new push opening system and soft-closing mechanism. Drawers and hinged doors fronts are available in glossy, matt, sahara, taiga and diamante lacquered glass or in Litech, in sahara and taiga wood with a three-dimensional effect, with a total of 165 finishings.

IT Nella versione libreria Zenit amplia le proprie potenzialità progettuali con l'introduzione di un montante retroilluminato e di contenitori sospesi che, come tutte le attrezzature di Zenit, sono liberamente posizionabili. I cassetti in alluminio, con guide ad estrazione totale sono dotati di un inedito sistema di apertura push e rientro ammortizzato. Il rivestimento dei cassetti e delle ante è disponibile in vetro laccato lucido, opaco, sahara, taiga e diamante oppure in Litech, in essenza sahara e taiga con effetto tridimensionale, per un totale di 165 finiture.

DE In der Ausführung als Bücherregal erweitert Zenit sein Gestaltungspotenzial durch die Einführung einer hinterleuchteten Basis und von Hängeschränken, die, wie alle Zenit-Einrichtungen, frei positioniert werden können. Die Aluminium-Schubladen mit Vollauszug sind mit einem neuartigen Push-Open-System und Soft-Close-Rückführung ausgestattet. Die Paneele der Schubladen und Türen sind in glänzend oder matt lackiertem Glas, Taiga, Sahara und Diamante oder in Litech, Sahara- und Taigaholz mit dreidimensionalem Effekt erhältlich, insgesamt stehen 165 Ausführungen zur Verfügung.

FR Dans sa version bibliothèque, Zenit élargit son potentiel modulaire avec l'introduction d'un montant rétroéclairé et d'éléments de rangement suspendus qui, comme tous les équipements Zenit, peuvent être librement positionnés. Les tiroirs en aluminium, qui disposent de glissières entièrement extractibles, sont équipés d'un système inédit d'ouverture à pression avec amortisseur de fermeture. Le revêtement des tiroirs et des portes est disponible en verre laqué brillant, mat, sahara, taiga et diamante ou en Litech, dans les essences sahara et taiga avec effet 3D, pour un total de 165 finitions disponibles.

ES En su versión de librería, Zenit amplía su potencial de diseño espacial con la introducción de un inédito elemento vertical retroiluminado y contenedores suspendidos que, como todos los productos de Zenit, se pueden colocar libremente. Los cajones de aluminio, con guías totalmente extraíbles, cuentan con un inédito sistema de apertura push y retorno amortiguado. El revestimiento de cajones y puertas está disponible en vidrio lacado brillante, opaco, sahara, taiga y diamante o en Litech, en madera sahara y taiga con efecto tridimensional, para un total de 165 acabados.

RU В стеллажа Zenit расширяет свои собственные проектные возможности благодаря использованию стойки с подсветкой и подвесным ящикам для хранения, которые, как и все навесные элементы Zenit, можно размещать в любом месте. Алюминиевые ящики с направляющими полного выдвижения оснащены новой системой пуш-пулл с амортизаторами. Отделка ящиков и фасадов доступна из глянцевого, матового, крашеного стекла, а также декоративного стекла sahara, taiga и diamante, а также из Litech, шпона sahara и taiga с трехмерным эффектом – всего доступно 165 вариантов отделки.

汉语 Zenit 书柜扩大了设计潜力，推出背部照明式立柱和悬吊式收纳空间，如同 Zenit 的所有部件，它们皆可自由配置。铝合金打造的抽屉设有抽拉式导轨，并搭配新型推弹系统和软关闭功能。抽屉和门扇的表面处理有亮面漆和哑光漆玻璃、Sahara、Taiga、Diamante、和 Litech 岩板可供选择；Sahara 木材和 Taiga 木材具有立体效果，共有 165 表面处理可供选择。

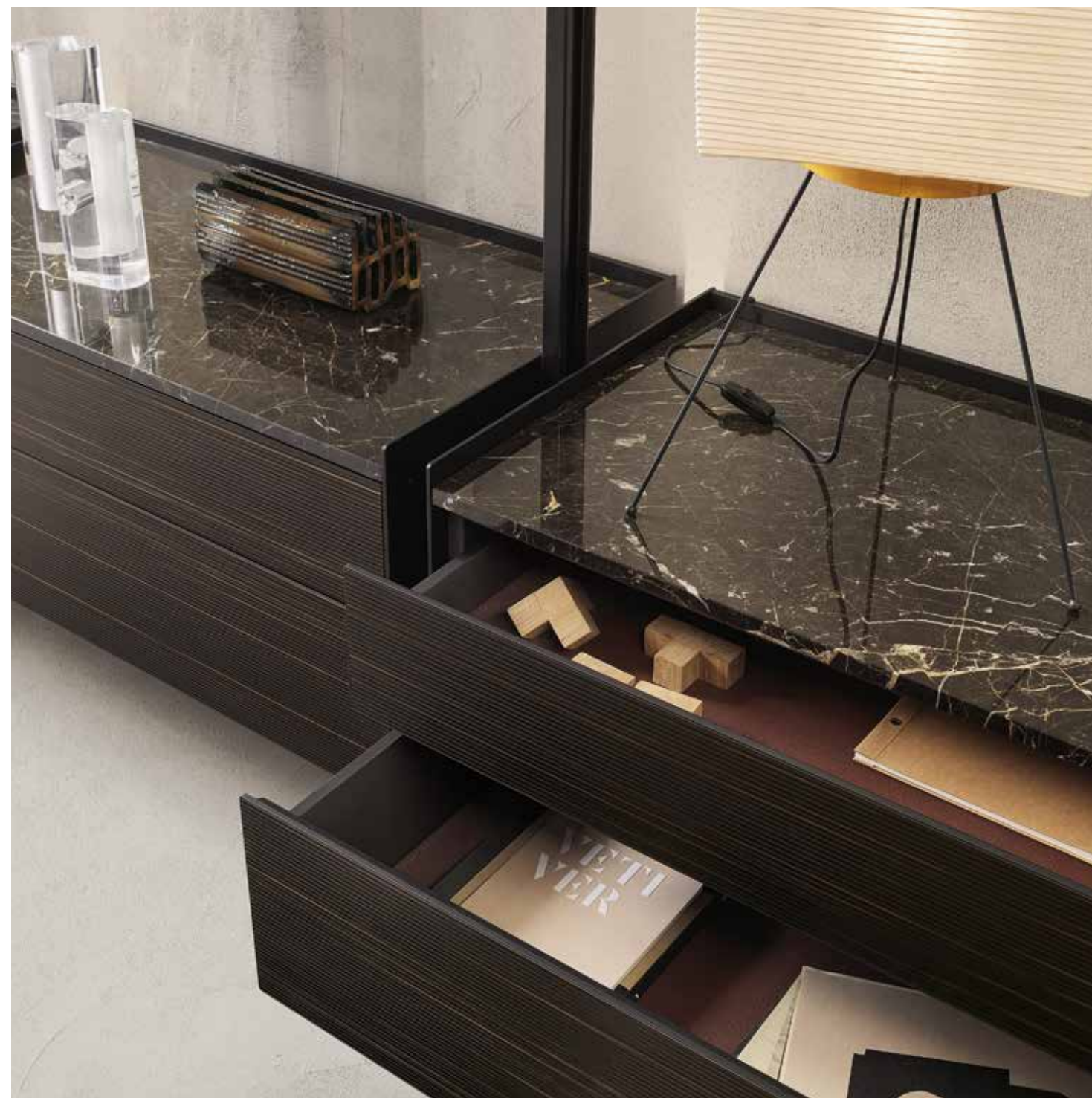

Structure: 13 nero
Glass shelves: 63 grigio trasparente
Fronts: 700 tinto ebano taiga
Marble top: 183 noir saint laurent
Internal drawers in synthetic leather: 156 rubens



BOOKCASES / ZENIT

Structure: 13 nero
Glass shelves: 63 grigio trasparente
Fronts: 700 tinto ebano taiga
Synthetic leather Internal door covering: 156 rubens
Internal back panel: 68 specchio grigio

EN The indirect lighting system allows a latest generation LED to be inserted into the iconic upright which is only 25 mm wide, keeping the design of the original 1997 ceiling and wall fixing system unchanged. Thus, the Zenit bookcase system can be updated and improved over time without replacements or aesthetic variations, in line with the sustainability and durability common to the Rimadesio collection.

IT Il sistema di illuminazione a luce indiretta permette di inserire un led di ultima generazione nell'iconico montante di soli 25 mm di larghezza, mantenendo immutato il design del sistema di fissaggio a soffitto e a parete originale del 1997. In questo modo, il sistema libreria Zenit viene aggiornato e migliorato nel tempo senza sostituzioni né variazioni estetiche, in un'ottica di sostenibilità e durabilità comune agli arredi Rimadesio.

DE Das indirekte Beleuchtungssystem ermöglicht es, eine hochmoderne LED in der ikonischen Decken- und Wandmontagesystems von 1997 beizubehalten. Auf diese Weise wird das Bücherregalsystem Zenit im Laufe der Zeit aktualisiert und verbessert, ohne dass es ersetzt oder ästhetisch verändert werden muss, unter dem Aspekt der Nachhaltigkeit und Langlebigkeit, die für die Möbel von Rimadesio selbstverständlich sind.

FR Le système d'éclairage indirect permet d'insérer une LED de dernière génération dans le montant emblématique de seulement 25 mm de large, en conservant intact le design du système de fixation au plafond et au mur, dont l'origine remonte à 1997. Le système de bibliothèque Zenit est ainsi actualisé et amélioré au fil du temps sans remplacements ni modifications esthétiques, dans cette optique éco-responsable et durable propre aux meubles Rimadesio.

ES El sistema de iluminación indirecta permite insertar un LED de última generación en el icónico montante de solo 25 mm de ancho, manteniendo intacto el diseño del sistema original de fijación a techo y a pared de 1997. De esta forma, el sistema de librería Zenit se actualiza y mejora en el tiempo sin sustituciones ni variaciones estéticas, con la mirada puesta en la sostenibilidad y la durabilidad propias del mobiliario Rimadesio.

RU Система непрямого освещения позволяет встроить современный светодиод в культовую стойку шириной всего 25 мм, сохранив при этом дизайн оригинальной системы крепления к потолку и стене 1997 года. Таким образом, без значительных эстетических изменений система книжных шкафов Zenit была обновлена и улучшена в соответствии с современными тенденциями с целью обеспечения устойчивости и долговечности, характерных для мебели Rimadesio.

汉语 间接照明系统能将最新一代的 LED 灯嵌入宽度仅 25 毫米的经典款立柱内，保留了 1997 年天花板和墙面固定系统的设计。通过此法，Zenit 改良书柜系统与与时俱进，不断更新改良，美感却始终如一，进而体现 Rimadesio 家具可持续发展性和耐用性的共同点。

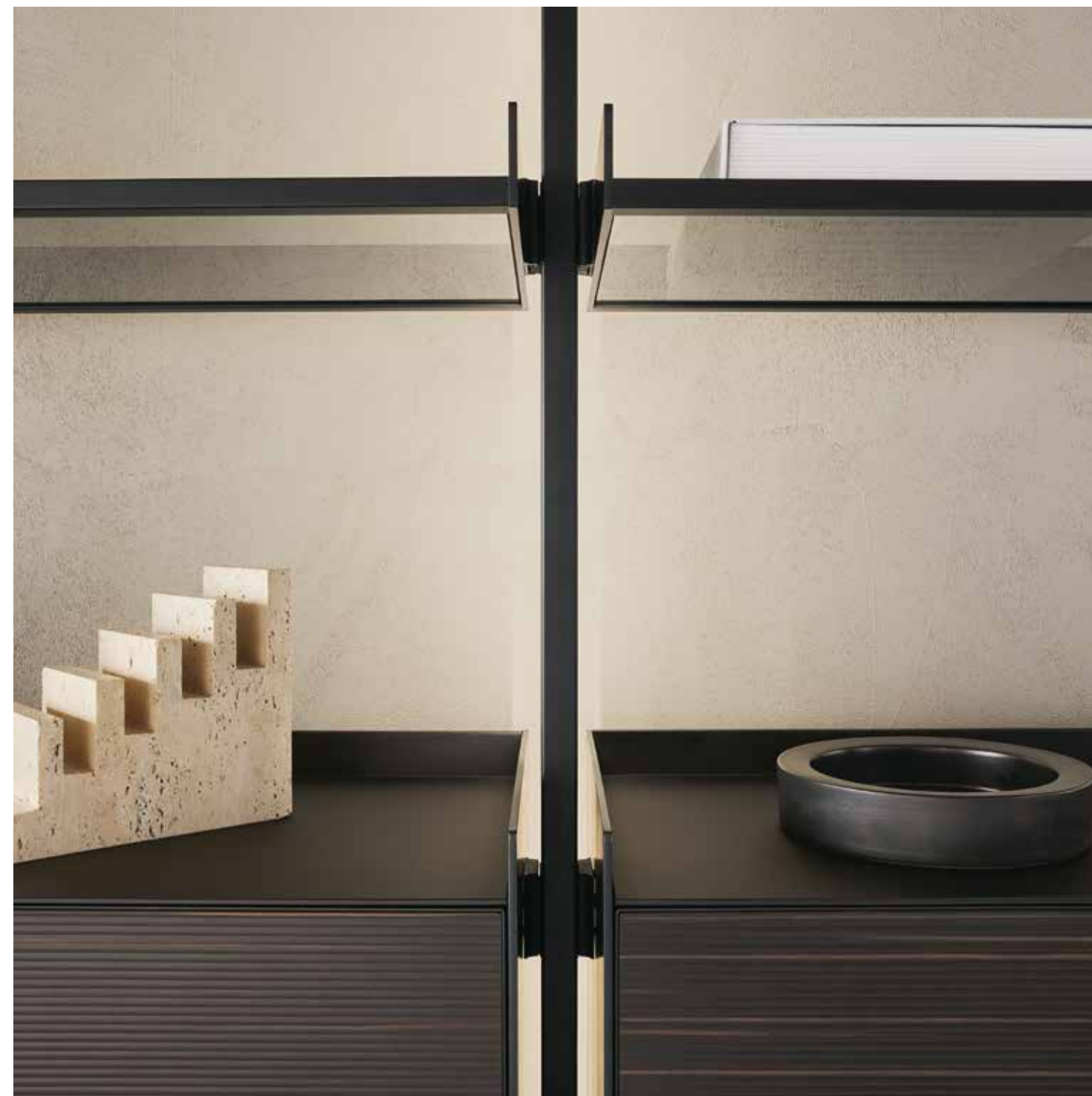





BOOKCASES / ZENIT

Structure: 83 piombo
Glass shelves: 60 rete alluminio
W 3690 H 2700 D 340

In this photo
Table: Francis
Partition wall system: Spazio
Coffee table: Tray

EN The aluminium upright guarantees the maximum structural solidity. The bayonet fixing system allows every single element to be installed perfectly leveled. The wall and ceiling uprights allow any possible composition.

IT Il montante in alluminio garantisce la massima solidità strutturale alle composizioni Zenit e il sistema di aggancio a baionetta consente di posizionare in bolla ogni singolo elemento. I montanti sono disponibili "a soffitto" e "a parete" per consentire la collocazione del sistema in ogni ambiente.

DE Der Montageposten aus Aluminium garantiert eine maximale Stabilität für eine Zenit Kompositionen und das Bajonettkupplungssystem ermöglicht ein waagerechte Positionierung jedes einzelnen Elements. Diese Montageposten sind als Decken- und Wand-Montage erhältlich, sodass das System in jeder Raum platziert werden kann.

FR Le montant en aluminium garantit une solidité structurelle maximale aux compositions Zenit et le système de fixation à baïonnette permet de positionner à niveau chaque élément individuel. Les montants sont disponibles à plafond et à mur pour permettre au système d'être positionné dans n'importe quel environnement.

ES El montante de aluminio garantiza la máxima solidez estructural a las composiciones Zenit y el sistema de fijación permite colocar cada elemento individual a nivel. Los montantes están disponibles "a techo" y "a pared" para permitir de colocar el sistema en cualquier situación.

RU Алюминиевая стойка гарантирует максимальную конструктивную прочность композициям Zenit, а бесшаговая система крепления позволяет выставить по уровню каждый из навесных элементов. Стойки могут крепиться к потолку или к стене, что позволяет установить систему в любом помещении.

汉语 铝制立柱保证了结构的最大坚固性。卡口式固定系统使每个元件都能完美地安装在水平面上。墙壁和天花板立柱允许任何可能的组合。

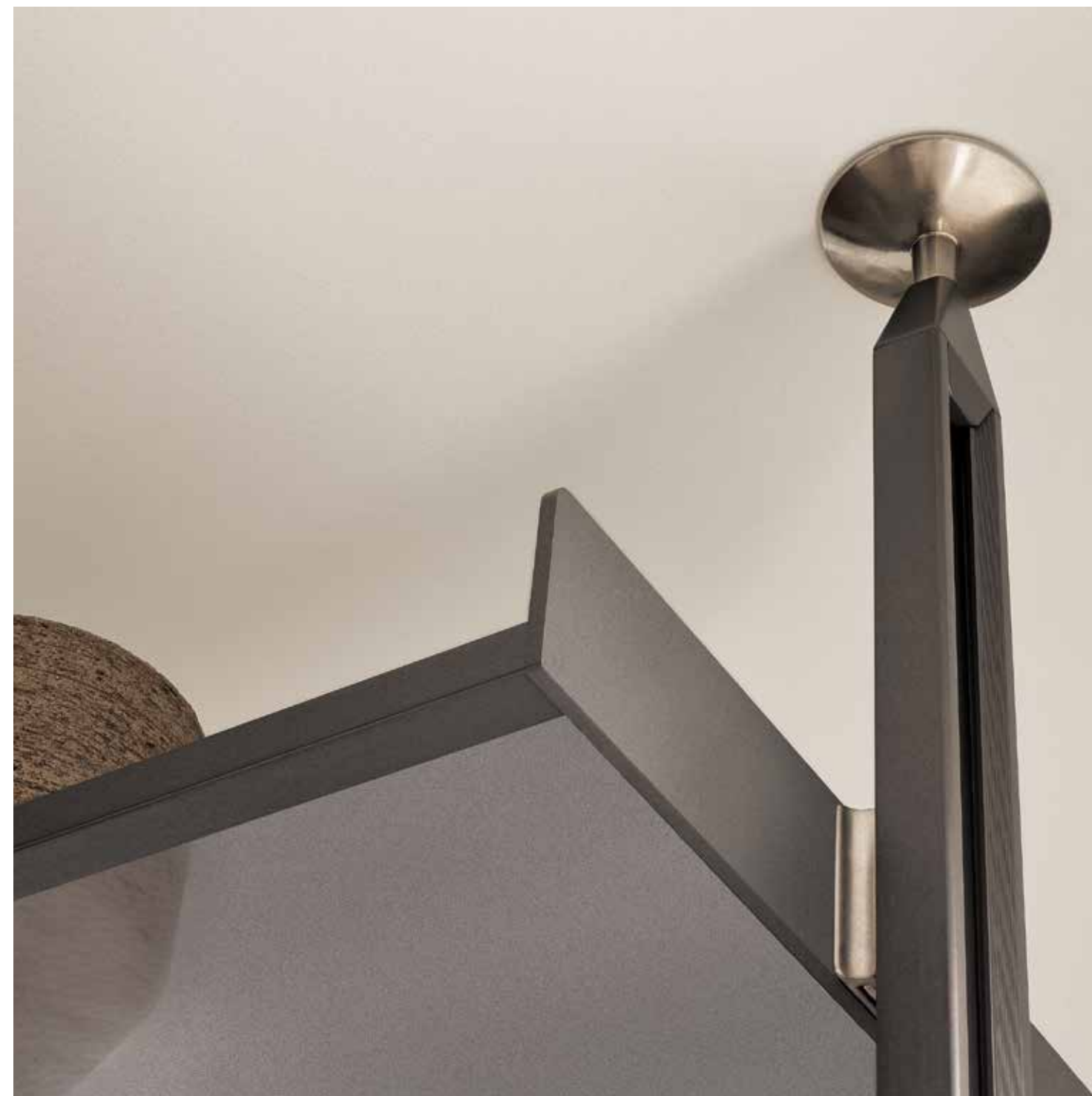



BOOKCASES / ZENIT



BOOKCASES / ZENIT

Structure: 304 platino
Fronts: 17 noce sahara
Glass shelves: 61 rete inox
Glass top: 137 platino opaco
Synthetic leather internal door covering: 154 argilla



BOOKCASES / ZENIT

Structure: 304 platino
Fronts: 17 noce sahara
Glass shelves: 61 rete inox
Glass top: 137 platino opaco
W 6090 H 3000 D 500

In this photo
Coffee table: Tray

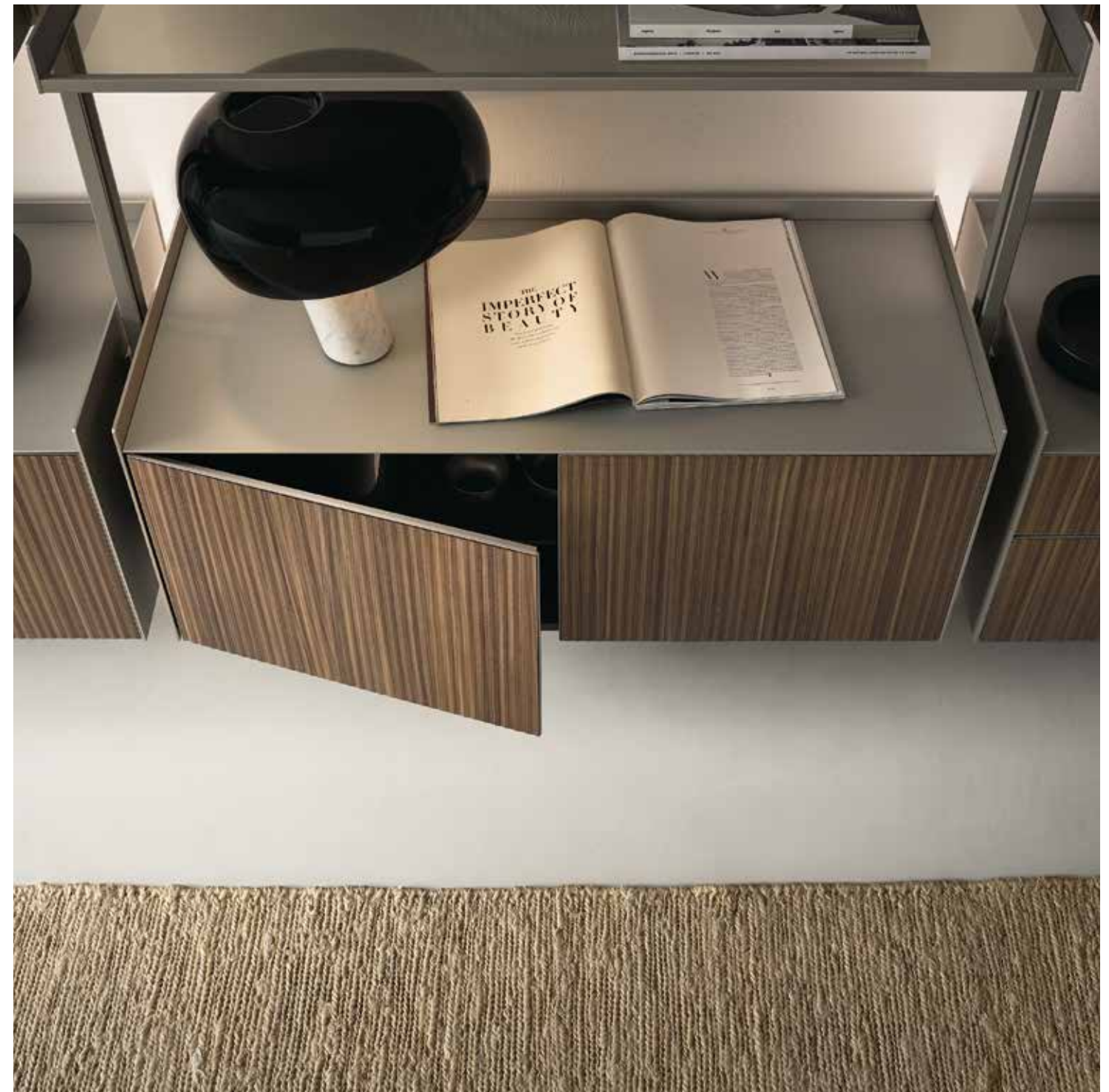

BOOKCASES / ZENIT

Structure: 304 platino
Fronts: 17 noce sahara
Glass shelves: 61 rete inox
Glass top: 137 platino opaco
Internal drawers in synthetic leather: 154 argilla



BOOKCASES / ZENIT

Structure: 14 brown
Glass shelves: 63 grigio trasparente
W 7290 H 3000 D 340



BOOKCASES / ZENIT

Structure: 304 platino
Suspended drawer unit: 404 platino diamante
Glass shelves and suspended glass cabinets:
00 trasparente
W 5090 H 2700 D 500

In this photo
Coffee table: Planet

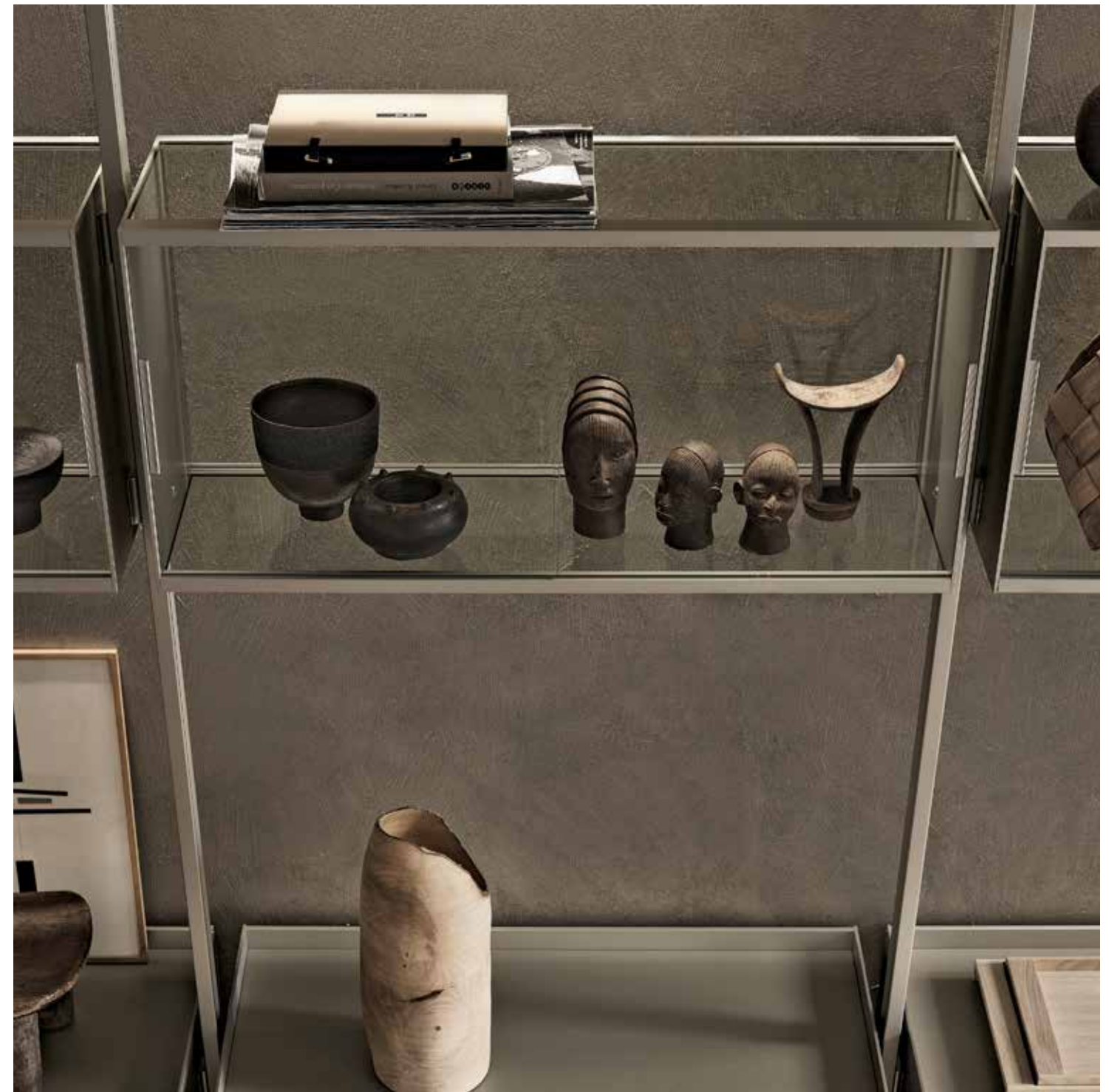





BOOKCASES / ZENIT

Structure: 304 platino
Suspended drawer unit: 404 platino diamante
Glass shelves and suspended glass cabinets:
00 trasparente

Zenit bookcase

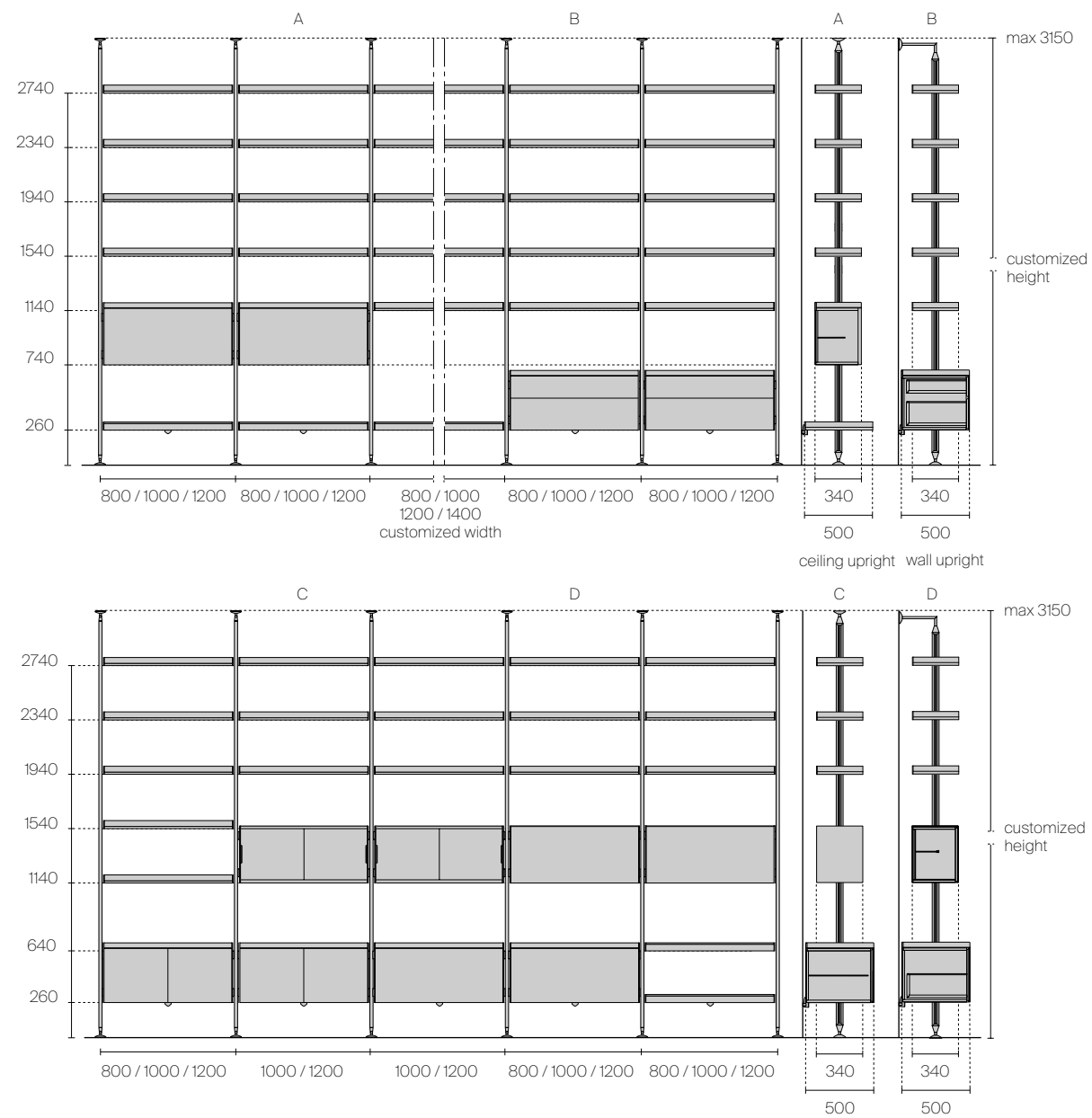

Encumbrance of the linear composition with shelves only

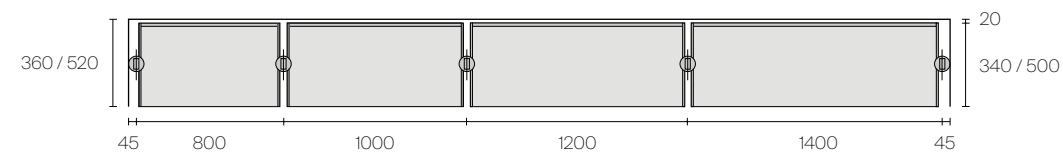

TECHNICAL DESCRIPTION

EN Zenit compositions are always custom-made in height, with wall or ceiling uprights. Shelves and TV shelf holders are available in four widths, up to a maximum size of 1400 mm.

IT Le composizioni Zenit vengono sempre realizzate su misura in altezza, con possibilità di montanti a parete o a soffitto. Le mensole e i mensoloni sono disponibili in quattro larghezze, fino alla dimensione massima di 1400 mm.

DE Zenit Anlage sind immer nach Mass in Hoehe, mit Wand oder Decke-Pfosten hergestellt. Fachboeden und Top-Fachboeden sind mit vier Breiten verfuegbar in larghezza, bis zu einer maximalen Breite von 1400 mm.

FR Les compositions Zenit sont toujours sur mesure en hauteur, avec les montants à fixation murale ou au plafond. Les étagères, et les étagères base sont disponibles en quatre largeurs, jusqu' à une dimension maxi de 1400 mm.

ES Las composiciones Zenit están siempre realizadas a medida en altura, con posibilidad de montantes a pared o a techo. Los estantes, y los estantes base están disponibles en cuatro anchuras, máxima medida de 1400 mm.

RU Композиции Zenit всегда изготавливаются по индивидуальному размеру по высоте, с возможностью настенного или потолочного монтажа стоек. Полки доступны в четырех размерах по ширине, вплоть до Максимальных 1400 мм.

汉语 Zenit 组合件的高度皆按尺寸定制，立柱可安装于墙面或天花板。层板和层板托有四种宽度可供选择，最大尺寸为 1400 毫米。

TV Hi-Fi shelf holder with lower shelf for decoder

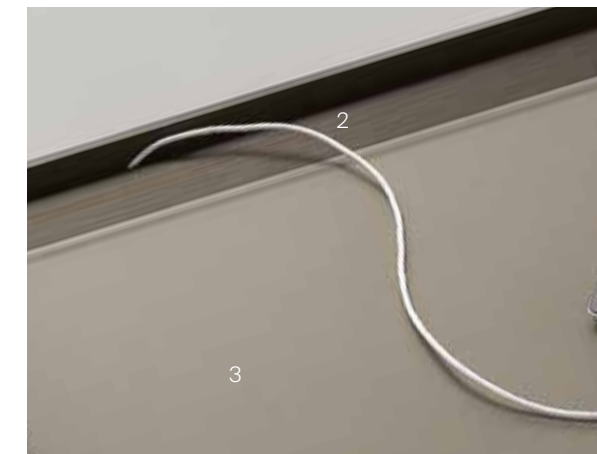

1. Aluminium support for decoder in 14 brown
2. Aluminium cable channeling in 14 brown
3. Lacquered tempered glass in 99 caffè

UPRIGHTS



1. Ceiling upright
2. Wall upright
3. Shelf with perimetrical ring in extruded aluminium
4. Bayonet fixing between the shelf and the die casting support
5. Structural upright in extruded aluminium
6. Support with expansion fixing system which allows to adjust the position of the accessories



Ceiling

Ceiling backlighted

Wall

Wall backlighted

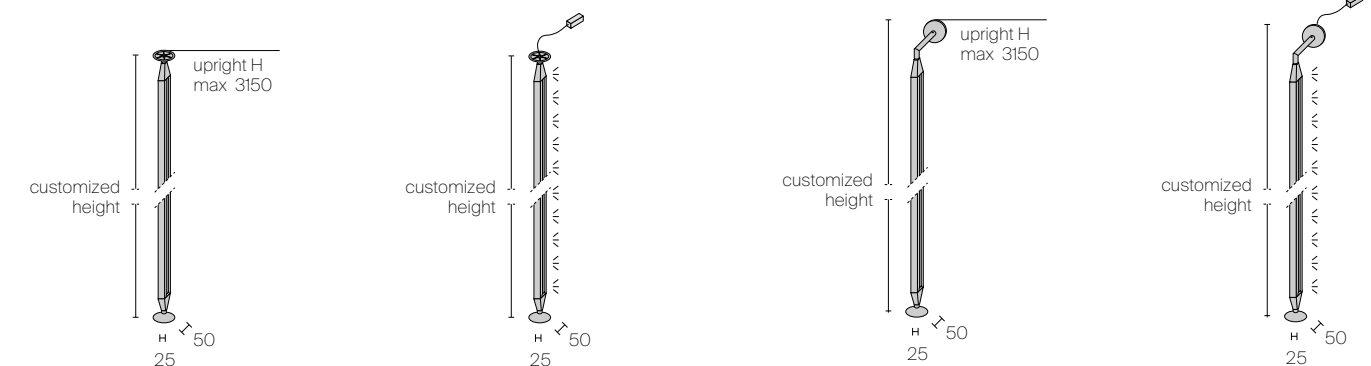

TECHNICAL DATA

ACCESSORIES

Suspended unit with drawers

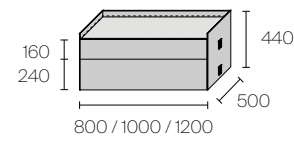

Suspended unit with drawer and flap door

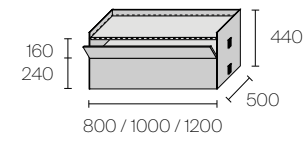

Suspended unit with drawer

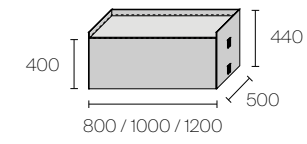

Suspended unit with hinged doors

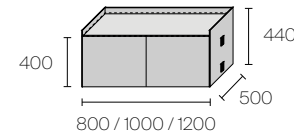

Suspended unit with flap door high side

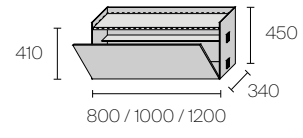

Suspended unit with flap door low side

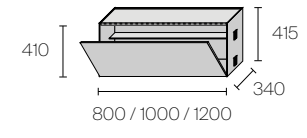

Suspended glass cabinet with sliding doors

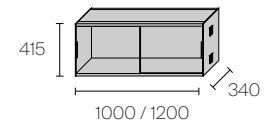

Optional glass shelf. Available for unit with hinged doors.

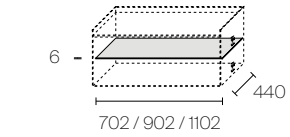

Optional synthetic leather mat for internal lining

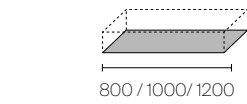

Glass finishing top thickness 4mm

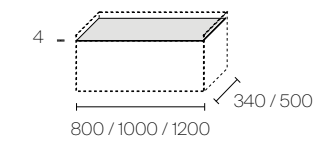

Litech finishing top thickness 4mm

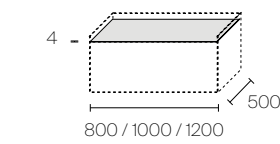

Marble finishing top thickness 20mm

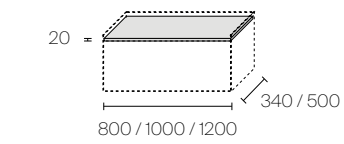

Glass shelf

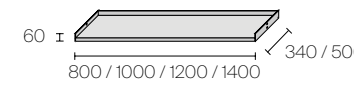

Glass shelf covered with synthetic leather

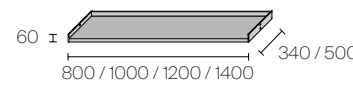

TV Hi-Fi shelf holder in lacquered glass with support for decoder

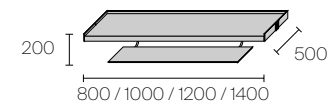

Optional adjustable wall thrust block with support for decoder

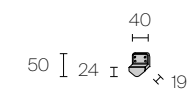

Optional cable duct for units depth 500. Not available for units with marble top.

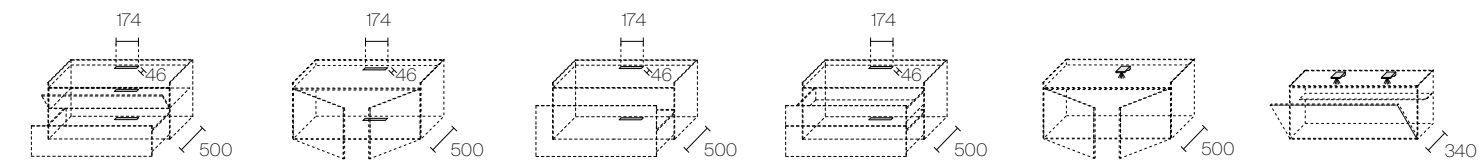

Battery led spotlight

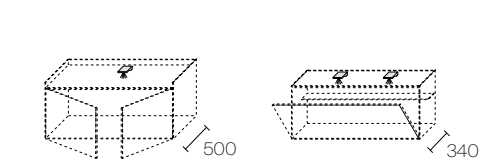

SUSPENDED DRAWER UNITS TYPOLOGIES



1



2



3



4



5



6



7

1. Suspended unit with drawers
2. Suspended unit with drawer and flap door
3. Suspended unit with drawer
4. Suspended unit with hinged doors
5. Suspended unit with flap door D 340 low side
6. Suspended unit with flap door D 340 high side
7. Suspended glass cabinet with sliding doors

FINISHINGS

Structure and accessories

ALUMINIUM



Suspended glass cabinet

TRANSPARENT GLASS

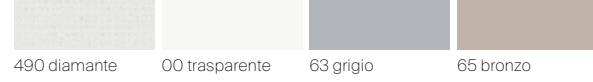

SATINATED GLASS



Suspended units

LACQUERED GLASS METALIZED GLASS



SAHARA GLASS



TAIGA GLASS



SAHARA METALIZED GLASS

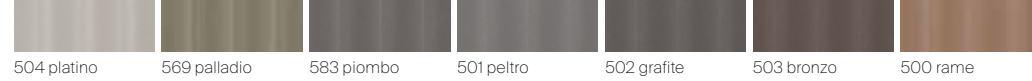

TAIGA METALIZED GLASS

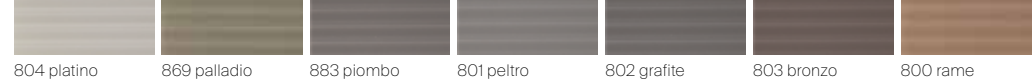

DIAMANTE GLASS



LITECH



SAHARA WOOD

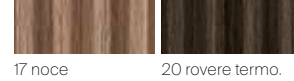

TAIGA WOOD

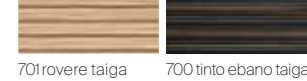

Finishing top for suspended units

LACQUERED GLASS METALIZED GLASS



DIAMANTE GLASS



MARBLE

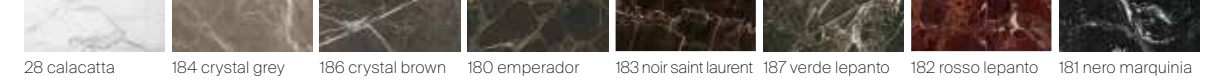

MATT MARBLE

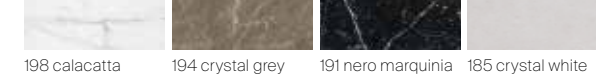

LITECH



Unit interior D 340

ALUMINIUM

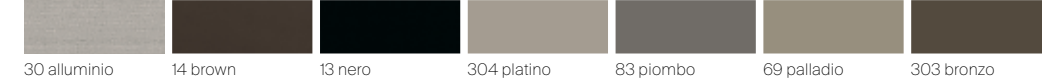

Unit interior D 500

INTERNAL MELAMINE



Shelf

TRANSPARENT GLASS

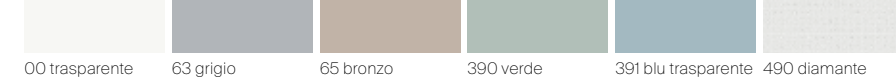

SATINATED GLASS



MESH GLASS



SYNTHETIC LEATHER

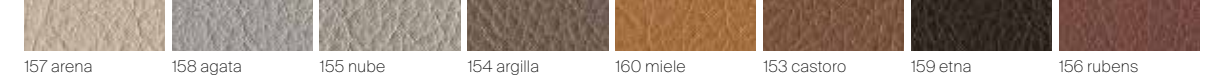

TV Hi-Fi shelf holder

LACQUERED GLASS METALIZED GLASS

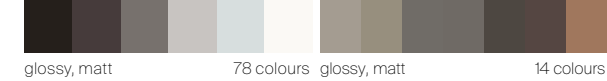

Mat for internal lining, internal flap door lining of units D 340

SYNTHETIC LEATHER

